



Refroidissement moteur

# RADIATEUR POIDS-LOURDS



Eau

Air

Clim

MAJ: 2018/11 V8

[www.cataldi.fr](http://www.cataldi.fr)



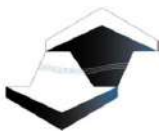

# NOTRE SAVOIR FAIRE

REFROIDISSEUR D'HUILE BOITE A VITESSE	P. 5
REVISION / REPARATION INTERCOOLER (Radiateur d'Air)	P. 5
REVISION / REPARATION RESERVOIR GASOIL ET HYDRAULIQUE	P. 6
PRESTATION SABLAGE TOUTES MATIERES	P. 6
PRESTATION SOUDAGE ALUMINIUM	P. 6

## RADIATEUR NEUF ET/OU ECHANGE STANDARD

<b>DAF</b>	RADIATEUR D'EAU	P. 7
	ECHANGEUR D'AIR SURALIMENTE (R.A.S.)	P. 8
	CONDENSEUR DE CLIMATISATION	P. 8
<b>IRISBUS</b>	RADIATEUR D'EAU	P. 9
	ECHANGEUR D'AIR SURALIMENTE (R.A.S.)	P. 9
	RADIATEUR DE CHAUFFAGE	P. 9
<b>IVECO</b>	RADIATEUR D'EAU	P. 10 à 12
	ECHANGEUR D'AIR SURALIMENTE (R.A.S.)	P. 13-14
	CONDENSEUR DE CLIMATISATION	P. 15
<b>MAN</b>	RADIATEUR D'EAU	P. 15-16
	ECHANGEUR D'AIR SURALIMENTE (R.A.S.)	P. 17-18
	CONDENSEUR DE CLIMATISATION	P. 18
<b>MERCEDES</b>	RADIATEUR D'EAU	P. 19 à 22
	ECHANGEUR D'AIR SURALIMENTE (R.A.S.)	P. 23-24
	CONDENSEUR DE CLIMATISATION	P. 24
<b>RENAULT TRUCKS</b>	RADIATEUR D'EAU	P. 25 à 30
	ECHANGEUR D'AIR SURALIMENTE (R.A.S.)	P. 31 à 34
	CONDENSEUR DE CLIMATISATION	P. 35
<b>SCANIA</b>	RADIATEUR D'EAU	P. 36
	ECHANGEUR D'AIR SURALIMENTE (R.A.S.)	P. 37
	CONDENSEUR DE CLIMATISATION	P. 37
<b>VOLVO</b>	RADIATEUR D'EAU	P. 38
	ECHANGEUR D'AIR SURALIMENTE (R.A.S.)	P. 39
	CONDENSEUR DE CLIMATISATION	P. 39
	VISCO-COUPLEUR	P. 40
	ECHANGEUR D'HUILE COMPLET AVEC VENTILATION	P. 41-42
	DURITES + SUPPORTS DE FIXATION	P. 43



## NOTRE ENGAGEMENT

Notre priorité demeure la satisfaction client.

L'engagement qualité de CATALDI sas est le suivant :

- **Anticipation !**
- **Réactivité !**
- **Optimisation !**

Cet engagement se traduit, pour nos clients, par une qualité de produit, un prix compétitif et une disponibilité.

## INFORMATIONS

Dans notre tarif, nombre de nos références sont proposées avec plusieurs variantes :

- **Pièce neuve (Radiateur complet avec montant latéraux)**
- **Pièce neuve sans joues (Radiateur complet sans montant latéraux)**
- **Pièce échange standard (Changement de faisceau)**

*Suivant les modèles, une ou plusieurs possibilités sont envisageables.*

## DIMENSIONS FAISCEAU

Il est indiqué sur ce catalogue, pour chacune des références, les dimensions faisceau.

La première dimension est la hauteur du faisceau entre les boîtes comme indiqué par la flèche numéro 1,

Exemple : 1000 x 700 x 50

La seconde dimension est la largeur du faisceau comme indiqué sur la flèche numéro 2,

La troisième dimension indique l'épaisseur du faisceau (3).

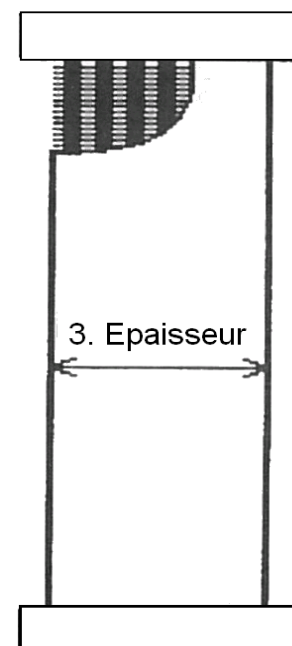
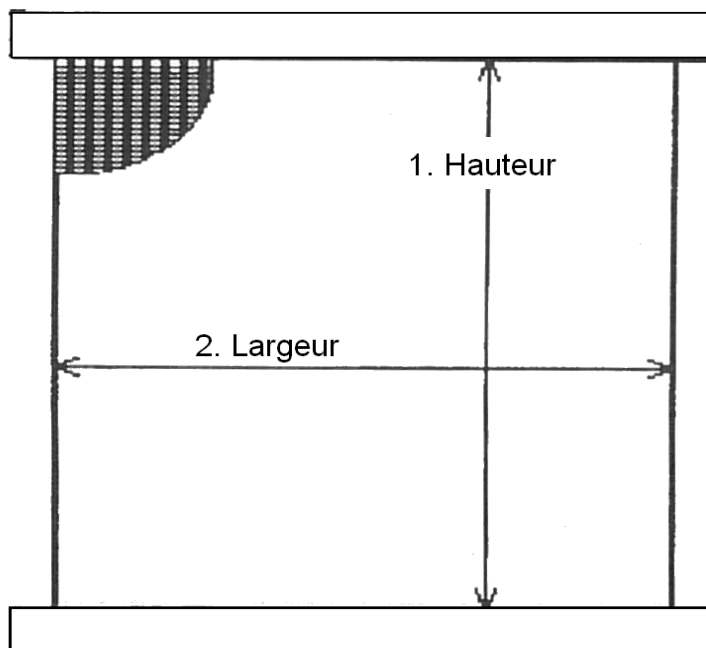

# NOTRE SAVOIR FAIRE

**ECHANGEUR D'HUILE  
BOITE A VITESSE  
REVISION / REPARATION  
NEUF : NOUS CONSULTER**



## REVISION REPARATION ECHANGEUR D'AIR (INTERCOOLER)



- Décapage intérieur / extérieur
- Sablage des angles
- Collage
- Contrôle air sous eau 70°C
- Peinture et emballage



## REVISION / REPARATION RESERVOIR GASOIL ET HYDRAULIQUE



**Prestation :**

- Révision
- Réparation
- Modification
- Fabrication

**Matière :**

- Aluminium
- Acier
- Inox

---

## PRESTATION SABLAGE TOUTE MATIERE

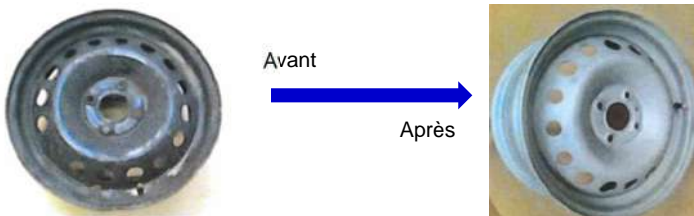

*Pour toutes pièces ayant  
pour dimensions maximum  
1200 mm x 700 mm x 500 mm*

---

## PRESTATION SOUDAGE ALUMINIUM

*Tous types de produits*



*Dimensions nous consulter.*





# RADIATEUR POIDS LOURDS

## DAF

### EAU

	<p><b>R519745</b></p> <p><b>LF55 250/290</b></p> <p>REF OE : 1403169 1407723</p> <p><b>Dimensions faisceau :</b> <b>750 x 538 x 43</b></p>		<p><b>R519744</b></p> <p><b>LF55</b></p> <p>REF OE : 1407725 1405413</p> <p><b>Dimensions faisceau :</b> <b>660 x 590 x 43</b></p>
	<p><b>R509585</b></p> <p><b>CF65/75</b></p> <p>REF OE : 1281400 1628515 / 1241580</p> <p><b>Dimensions faisceau :</b> <b>805 X 648 X 43</b></p>		<p><b>R61441A</b></p> <p><b>CF 85</b></p> <p>REF OE : 1627416 / 1434916 1434910 / 1760636</p> <p><b>Dimensions faisceau :</b> <b>850 X 650 X 43</b></p>
	<p><b>R509586</b></p> <p><b>CF85</b></p> <p>REF OE : 1265522 1628821 / 1831444 / 1324257</p> <p><b>Dimensions faisceau :</b> <b>905 X 648 X 43</b></p>		<p><b>R509679</b></p> <p><b>CF 85</b></p> <p>REF OE : 1627415 / 1371372 3222643 / 1739551 / 1698298</p> <p><b>Dimensions faisceau :</b> <b>950 X 648 X 53</b></p>
	<p><b>R730646</b></p> <p><b>95</b></p> <p>REF OE : 393433</p> <p><b>Dimensions faisceau :</b> <b>870 X 750 X 52</b></p>		<p><b>R509551</b></p> <p><b>XF 95</b></p> <p>REF OE : 0076449 / 0393435 / 1617342</p> <p><b>Dimensions faisceau :</b> <b>970 X 750 X 52</b></p>
	<p><b>R509559</b></p> <p><b>XF 105</b></p> <p>REF OE : 1739550 / 1674136 / 1861737 / 1856628 / 1692332</p> <p><b>Dimensions faisceau :</b> <b>1068 X 750 X 52</b></p>		<p><b>R732553</b></p> <p><b>XF 95</b></p> <p>REF OE : 1617340/102906/1326966/ 1858772/1617341/1858774</p> <p><b>Dimensions faisceau :</b> <b>1068 X 750 X 52</b></p>
	<p><b>R61449</b></p> <p><b>XF 105</b></p> <p>REF OE : 1909449 / 1940146 / 2049369 / 2114242</p> <p><b>Dimensions faisceau :</b> <b>975 X 1152 X 42</b></p>		

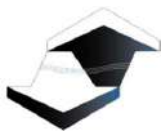

# RADIATEUR POIDS LOURDS

## DAF

### ECHANGEUR D'AIR SURALIMENTE (R.A.S.)

	<b>R30200</b>
	<b>XF105</b>
	REF OE : 1691394 1691392
	<b>Dimensions faisceau :</b> 553 X 852 X 50

	<b>R817369</b>
	<b>XF95</b>
	REF OE : 1327673 1619667
	<b>Dimensions faisceau :</b> 550 X 850 X 50

	<b>R520737</b>
	<b>CF85</b>
	REF OE : 1685549 / 1372296
	<b>Dimensions faisceau :</b> 520 X 737 X 62

	<b>FR95269762</b>
	<b>XF105</b>
	REF OE : 1909450 / 1993568
	<b>Dimensions faisceau :</b> 952 X 697 X 62

### CONDENSEUR DE CLIMATISATION

	<b>F40818986</b>
	<b>XF105</b>
	REF OE : 1629115
	<b>DIMENSIONS FAISCEAU :</b> 500 X 540 X 16



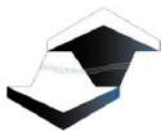

# RADIATEUR POIDS LOURDS

# IRISBUS

## EAU

	<b>R733440</b>		<b>R2210199</b>
	<b>ARES</b>		<b>CITELIS / HEULIEZ</b>
	REF OE : 5001857534		REF OE : 5001862877
	<b>Dimensions faisceau :</b> 910 X 790 X 70		<b>Dimensions faisceau :</b> 850 X 666 X 48
	<b>RRE2028</b>		<b>RRE2029</b>
	<b>AGORA</b>		<b>AGORA</b>
	REF OE : 5010393285		REF OE : 5010393166
	<b>Dimensions faisceau :</b> 630 X 537 X 46		<b>Dimensions faisceau :</b> 630 X 537 X 46
	<b>R730529</b>		<b>R2209948</b>
	<b>TRACER</b>		<b>RECREEO</b>
	REF OE : 5010079049		REF OE : 500021187 / 1451570
	<b>Dimensions faisceau :</b> 775 x 686 x 58		<b>Dimensions faisceau :</b> 900 x 708 x 52

## ECHANGEUR D'AIR SURALIMENTE (R.A.S.)

	<b>RRE4058</b>		<b>R8ML376724421</b>
	<b>ARES</b>		<b>CITELIS</b>
	REF OE : 5010494010 5001857536		REF OE : 5010556095
	<b>Dimensions faisceau :</b> 895 X 620 X 62		<b>Dimensions faisceau :</b> 593 x 612 x 66

## RADIATEUR CHAUFFAGE

	<b>C10RVRE6016</b>
	<b>CITELIS</b>
	REF OE : 5010104235
	<b>Dimensions faisceau :</b> 348 X 158 X 38



# RADIATEUR POIDS LOURDS

# IVECO

## EAU

	<p><b>E01730334</b></p> <p><b>DAILY 1989 A 1999</b></p> <p>REF OE : 93822906/93813747/9381374EB</p> <p>Dimensions faisceau : 625 X 382 X 34</p>		<p><b>E01816647</b></p> <p><b>DAILY 1989 A 1996</b></p> <p>REF OE : 1907918/93809326 93809189/93811429</p> <p>Dimensions faisceau : 638 X 451 X 34</p>
	<p><b>E01816647ORD</b></p> <p><b>DAILY 1989 A 1996 MONTAGE ORDONNEZ</b></p> <p>REF OE : 1907918 93809189</p> <p>Dimensions faisceau : 625 X 460 X 36</p>		<p><b>E01816649</b></p> <p><b>DAILY 1989 A 1996</b></p> <p>REF OE : 95809189 / 93809326</p> <p>Dimensions faisceau : 643 X 452 X 34</p>
	<p><b>E01731572</b></p> <p><b>DAILY 1989 A 1999 MONTAGE VALEO</b></p> <p>REF OE : 93824070 93813747 / 93825378</p> <p>Dimensions faisceau : 641 X 489 X 34</p>		<p><b>E011V2050</b></p> <p><b>DAILY 1989 A 1999 MONTAGE MODINE</b></p> <p>REF OE : 93818439 / 93822628 / 131226311 / 93822682 / 93818439EB / 506037 / 1403054</p> <p>Dimensions faisceau : 625 X 440 X 43</p>
	<p><b>E011V14020</b></p> <p><b>DAILY 35C11 A PARTIR ANNEE 2000</b></p> <p>REF OE : 99488591 / 99487905/500396429/504008108/5 04008110 / 504008102</p> <p>Dimensions faisceau : 640 X 480 X 34</p>		<p><b>E01BM015</b></p> <p><b>DAILY 35C12 A PARTIR ANNEE 2000</b></p> <p>REF OE : 504045489 / 504045487 504084141</p> <p>Dimensions faisceau : 649 X 440 X 34</p>
	<p><b>B201V2087</b></p> <p><b>DAILY HPI A PARTIR DE 2005</b></p> <p>REF OE : 504152996 / 504152995</p> <p>Dimensions faisceau : 650 X 456 X 32</p>		<p><b>B20640440</b></p> <p><b>DAILY</b></p> <p>REF OE : 5801264635</p> <p>Dimensions faisceau : 640 X 440 X 38</p>

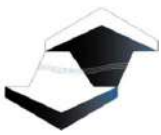

# RADIATEUR POIDS LOURDS

# IVECO

## EAU

	<p><b>E01730385</b></p> <p><b>EUROCARGO</b></p> <p>REF OE : 98402096/98425619/98425628</p> <p><b>Dimensions faisceau :</b> <b>539 X 594 X 62</b></p>		<p><b>R730378</b></p> <p><b>EUROCARGO</b></p> <p>REF OE : 98425628 98425619</p> <p><b>Dimensions faisceau :</b> <b>542 X 568 X 35</b></p>
	<p><b>R730379</b></p> <p><b>EUROCARGO</b></p> <p>REF OE : 98425703</p> <p><b>Dimensions faisceau :</b> <b>625 X 627 X 35</b></p>		<p><b>R730380</b></p> <p><b>EUROCARGO</b></p> <p>REF OE : 4849400/500318699</p> <p><b>Dimensions faisceau :</b> <b>570 X 626 X 35</b></p>
	<p><b>R62341</b></p> <p><b>EUROCARGO</b></p> <p>REF OE : 500380655</p> <p><b>Dimensions faisceau :</b> <b>570 X 560 X 33</b></p>		<p><b>R734872</b></p> <p><b>EUROCARGO TECTOR</b></p> <p>REF OE : 500361626/504080547</p> <p><b>Dimensions faisceau :</b> <b>555 X 569 X 40</b></p>
	<p><b>R733481</b></p> <p><b>EUROCARGO TECTOR</b></p> <p>REF OE : 500361629</p> <p><b>Dimensions faisceau :</b> <b>640 X 565 X 42</b></p>		<p><b>R53218</b></p> <p><b>CURSOR / EUROTECH</b></p> <p>REF OE : 99488785 /93192910 500326345</p> <p><b>Dimensions faisceau :</b> <b>900 X 775 X 43</b></p>
	<p><b>R730258</b></p> <p><b>CURSOR / EUROTECH</b></p> <p>REF OE : 93192909/41008464/42532037</p> <p><b>Dimensions faisceau :</b> <b>800 X 775 X 43</b></p>		<p><b>R730259</b></p> <p><b>CURSOR / EUROTECH</b></p> <p>REF OE : 93192910/41042094</p> <p><b>Dimensions faisceau :</b> <b>900 X 775 X 43</b></p>

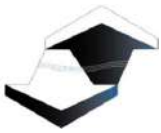

# RADIATEUR POIDS LOURDS

# IVECO

## EAU

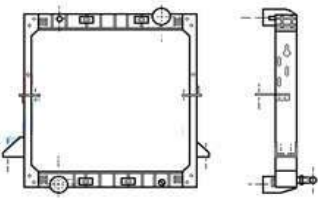
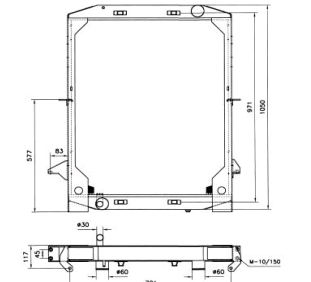
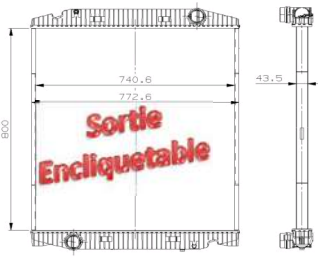
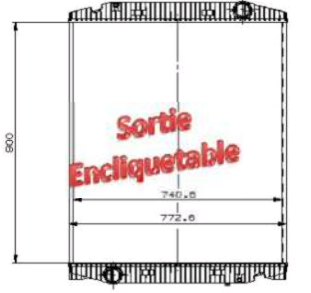
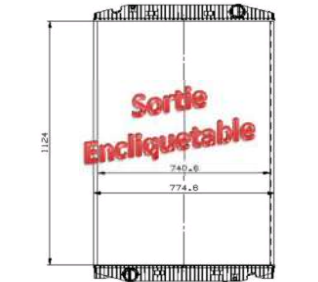
	<p><b>R730964</b></p> <p><b>EUROTECH</b></p> <p>REF OE : 93160529</p> <p>Dimensions faisceau : 800 X 775 X 43</p>		<p><b>R730965</b></p> <p><b>EUROTECH</b></p> <p>REF OE : 96160531</p> <p>Dimensions faisceau : 900 X 775 X 43</p>
	<p><b>R2209792</b></p> <p><b>STRALIS</b></p> <p>REF OE : 41218266</p> <p>Dimensions faisceau : 800 X 748 X 42</p>		<p><b>R2208413</b></p> <p><b>STRALIS</b></p> <p>REF OE : 504011119</p> <p>Dimensions faisceau : 900 X 748 X 42</p>
	<p><b>R2207833</b></p> <p><b>STRALIS</b></p> <p>REF OE : 41214447</p> <p>Dimensions faisceau : 1124 X 775 X 43</p>		

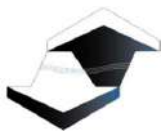

# RADIATEUR POIDS LOURDS

# IVECO

## ECHANGEUR D'AIR SURALIMENTE (R.A.S.)

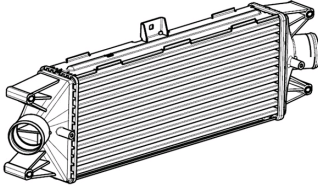
	<b>R818724</b>
	<b>DAILY</b>
	REF OE : 504084140 / 99487925 / 5801349166/504022617/580131364 0/ 504086501
	<b>DIMENSIONS FAISCEAU :</b> 475 X 185 X 63

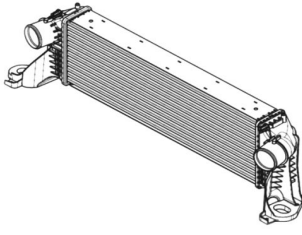
	<b>R30342</b>
	<b>DAILY</b>
	REF OE : 5801255907 / 5801526777
	<b>DIMENSIONS FAISCEAU :</b> 600 X 190 X 64

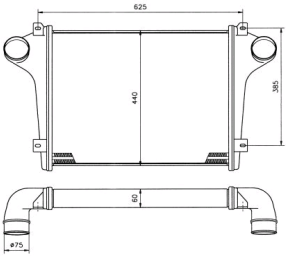
	<b>R30811</b>
	<b>EUROCARGO</b>
	REF OE : 4849402
	<b>DIMENSIONS FAISCEAU :</b> 540 X 435 X 50

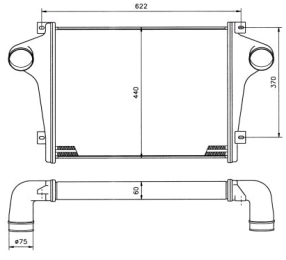
	<b>R30812</b>
	<b>EUROCARGO</b>
	REF OE : 98425621
	<b>DIMENSIONS FAISCEAU :</b> 540 X 435 X 50

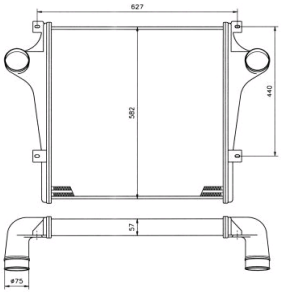
	<b>R30813</b>
	<b>EUROCARGO</b>
	REF OE : 98425705
	<b>DIMENSIONS FAISCEAU :</b> 540 X 577 X 50

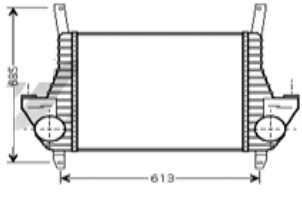
	<b>R97032</b>
	<b>EUROCARGO TECTOR</b>
	REF OE : 500380659
	<b>DIMENSIONS FAISCEAU :</b> 520 X 430 X 50

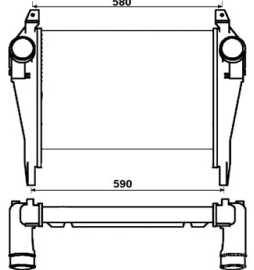
	<b>R818778</b>
	<b>EUROCARGO TECTOR</b>
	REF OE : 504028468
	<b>DIMENSIONS FAISCEAU :</b> 532 X 367 X 50

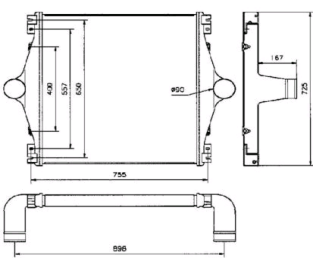
	<b>R816846</b>
	<b>EUROTECH / EUROSTAR</b>
	REF OE : 93160530 41016520
	<b>DIMENSIONS FAISCEAU :</b> 650 X 717 X 50

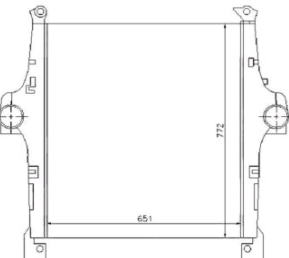
	<b>R2209790</b>
	<b>STRALIS</b>
	REF OE : 41218267
	<b>DIMENSIONS FAISCEAU :</b> 651 X 772 X 50

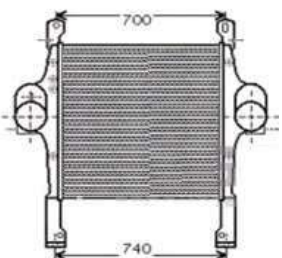
	<b>R2208412</b>
	<b>STRALIS</b>
	REF OE : 504015564
	<b>DIMENSIONS FAISCEAU :</b> 655 X 777 X 50



# RADIATEUR POIDS LOURDS

## IVECO

### ECHANGEUR D'AIR SURALIMENTE (R.A.S.)

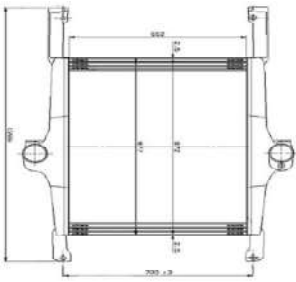
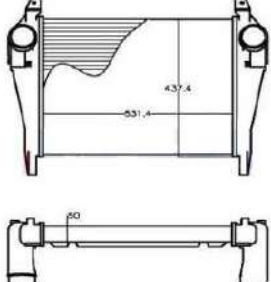
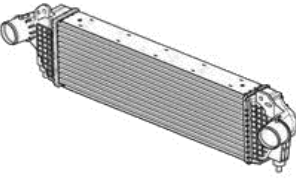
	<p><b>R2207834</b></p> <p><b>STRALIS</b></p> <p>REF OE : 41214448</p> <p><b>DIMENSIONS FAISCEAU :</b> 655 X 877 X 50</p>		<p><b>R818777</b></p> <p><b>EUROCARGO</b></p> <p>504028467</p> <p><b>DIMENSIONS FAISCEAU :</b> 531 X 437 X 50</p>
	<p><b>R30343</b></p> <p><b>DAILY</b></p> <p>REF OE : 5801526779 / 5801255806</p> <p><b>DIMENSIONS FAISCEAU :</b> 600 X 190 X 64</p>		

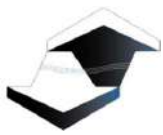

# RADIATEUR POIDS LOURDS

# IVECO

## CONDENSEUR DE CLIMATISATION

	<b>F40818037</b>
	<b>DAILY</b>
	REF OE : 504022601
	<b>DIMENSIONS FAISCEAU :</b> 648 X 310 X 16

	<b>F40818036</b>
	<b>DAILY</b>
	REF OE : 99487944 504090674
	<b>DIMENSIONS FAISCEAU :</b> 700 X 312 X 18

	<b>F4035751</b>
	<b>DAILY HPI</b>
	REF OE : 504084147 504256333
	<b>DIMENSIONS FAISCEAU :</b> 570 X 338 X 16

	<b>F4035451</b>
	<b>EUROCARGO</b>
	REF OE : 8189330 7036303505
	<b>DIMENSIONS FAISCEAU :</b> 570 X 480 X 20

	<b>F4035625</b>
	<b>STRALIS</b>
	REF OE : 41214450
	<b>DIMENSIONS FAISCEAU :</b> 610 X 440 X 16

## MAN EAU

	<b>R51569</b>
	<b>L2000</b>
	REF OE : 81061016397 1237775 / 1331032/12378252 81061016010 / 1331024
	<b>Dimensions faisceau :</b> 590 X 648 X 43

	<b>R51590</b>
	<b>L2000</b>
	REF OE : 81061016002 1561687 / 1337880
	<b>Dimensions faisceau :</b> 650 X 620 X 52

	<b>R51528</b>
	<b>M90 / M2000</b>
	REF OE : 81061016380 1604941
	<b>Dimensions faisceau :</b> 705 X 633 X 43



	<b>R51604</b>
	<b>L2000</b>
	REF OE : 85061016466 3067113
	<b>Dimensions faisceau :</b> 705 X 633 X 43



# RADIATEUR POIDS LOURDS

## MAN

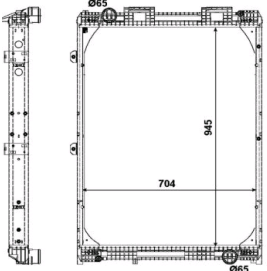
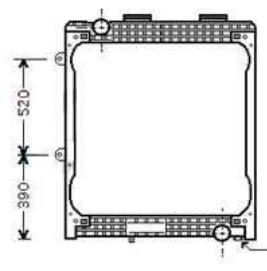
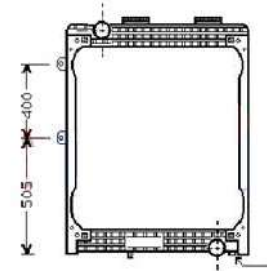
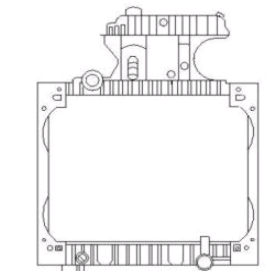
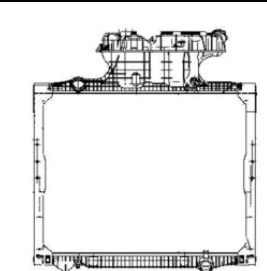
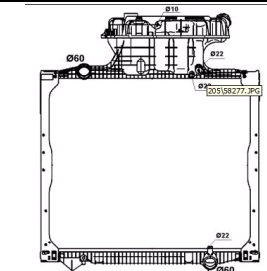
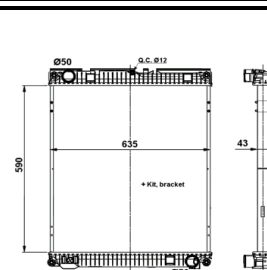
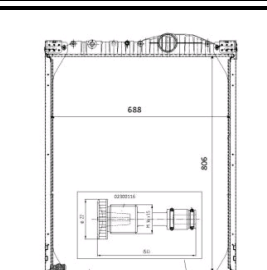
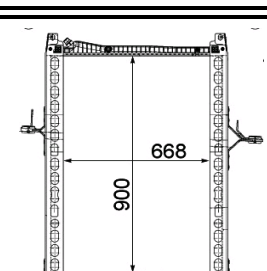
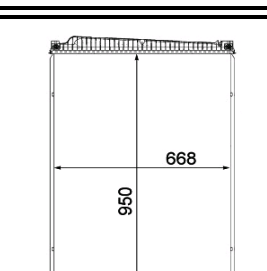
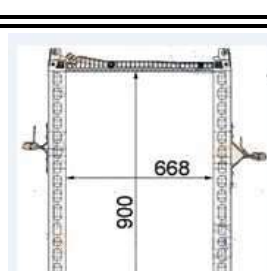
### EAU

	<p><b>R2204095</b></p> <p><i>F2000</i></p> <p>REF OE : 81061016423 81061006230 / 81061006229 81061016407 / 81061016438</p> <p><b>Dimensions faisceau :</b> 945 X 735 X 43</p>		<p><b>R2207947</b></p> <p><i>F2000</i></p> <p>REF OE : 81061016437</p> <p><b>Dimensions faisceau :</b> 945 X 735 X 43</p>
	<p><b>R2204091</b></p> <p><i>F2000</i></p> <p>REF OE : 81061016421</p> <p><b>Dimensions faisceau :</b> 1065 X 735 X 43</p>		<p><b>R733428</b></p> <p><i>TGA</i></p> <p>REF OE : 81061016510 / 81061016468 / 81061016472 / 81061006463 / 81061016458 / 81061016518</p> <p><b>Dimensions faisceau :</b> 765 X 983 X 42</p>
	<p><b>R733429</b></p> <p><i>TGA</i></p> <p>REF OE : 81061016512 / 81061010059 / 81061016459 / 81061016462 / 81061016469 / 81061016473 / 81061016477 / 81061206512 / 81061016520</p> <p><b>Dimensions faisceau :</b> 920 X 938 X 42</p>		<p><b>R58277</b></p> <p><i>TGA</i></p> <p>REF OE : 81061016511 81061016482 81061016519</p> <p><b>Dimensions faisceau :</b> 938 X 845 X 42</p>
	<p><b>R67224</b></p> <p><i>TGL</i></p> <p>REF OE : 81061016492</p> <p><b>Dimensions faisceau :</b> 590 X 640 X 40</p>		<p><b>R503309</b></p> <p><i>special BUS NL / NG / NU</i></p> <p>REF OE : 81061016451</p> <p><b>Dimensions faisceau :</b> 806 X 688 X 53</p>
	<p><b>R8MK376755641</b></p> <p><i>TGM</i></p> <p>REF OE : 81061010064</p> <p><b>Dimensions faisceau :</b> 900 x 668 x 40</p>		<p><b>R8MK376755391</b></p> <p><i>TGM</i></p> <p>REF OE : 81061010061</p> <p><b>Dimensions faisceau :</b> 950 X 668 X 40</p>
	<p><b>R8MK376755641</b></p> <p><i>TGL</i></p> <p>REF OE : 81061010064</p> <p><b>Dimensions faisceau :</b> 900 X 668 X 40</p>		<p><b>R67193</b></p> <p><i>TG</i></p> <p>REF OE : 81061010061</p> <p><b>Dimensions faisceau :</b> 950 X 668 X 40</p>



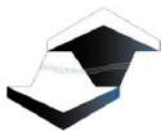

# RADIATEUR POIDS LOURDS

# MAN

## ECHANGEUR D'AIR SURALIMENTE (R.A.S.)

	<b>R30036</b>
	<b>M90</b>
	REF OE : 8106130048
	<b>Dimensions faisceau :</b> 595 X 417 X 50

	<b>R30125</b>
	<b>M2000</b>
	REF OE : 81061300144
	<b>Dimensions faisceau :</b> 595 X 423 X 62

	<b>R2204099</b>
	<b>F90</b>
	REF OE : 81061300024 / 81061300131
	<b>Dimensions faisceau :</b> 650 X 617 X 50

	<b>R2204097</b>
	<b>F90/F2000</b>
	REF OE : 81061300083
	<b>Dimensions faisceau :</b> 650 X 617 X 52

	<b>R2206773</b>
	<b>F90</b>
	REF OE : 81061300082
	<b>Dimensions faisceau :</b> 653 X 617 X 50

	<b>R2203934</b>
	<b>F90</b>
	REF OE : 81061300049
	<b>Dimensions faisceau :</b> 654 X 607 X 40

	<b>R30261</b>
	<b>TGL</b>
	REF OE : 81061300192 / 81061300228
	<b>Dimensions faisceau :</b> 535 X 512 X 50

	<b>R2210055</b>
	<b>TGA</b>
	REF OE : 81061300180 81061300198 / 81061300216 / 81061300232
	<b>Dimensions faisceau :</b> 665 X 892 X 64

	<b>R2210294</b>
	<b>TGA</b>
	REF OE : 81061300199 81061300204
	<b>Dimensions faisceau :</b> 665 X 892 X 64

	<b>R2210295</b>
	<b>TGA</b>
	REF OE : 81061300200 / 81061300205 / 81061300218 / 81061300203 / 81061300234
	<b>Dimensions faisceau :</b> 665 X 892 X 64

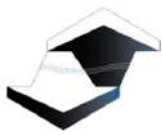

# RADIATEUR POIDS LOURDS

# MAN

## ECHANGEUR D'AIR SURALIMENTE (R.A.S.)

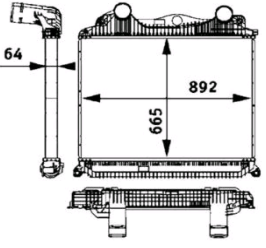
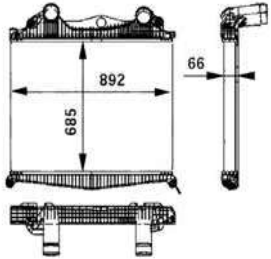
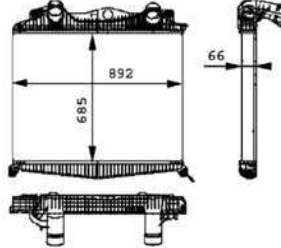
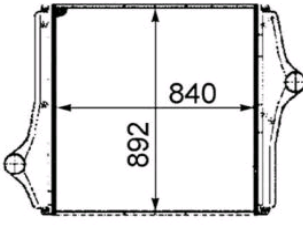
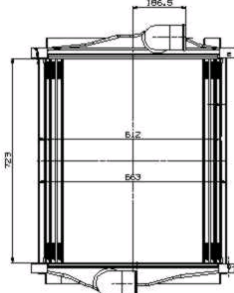
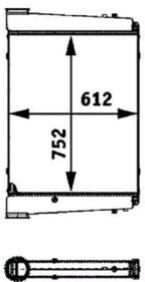
	<p><b>R2210783</b></p> <p><b>TGA</b></p> <p>REF OE : 81061300179 81061300197 / 81061300215</p> <p>Dimensions faisceau : 665 X 892 X 64</p>		<p><b>R2207073</b></p> <p><b>TGA</b></p> <p>REF OE : 81061300170 / 81061300156 81061300166 / 81061300174 81061300175 / 81061300179</p> <p>Dimensions faisceau : 685 X 892 X 66</p>
	<p><b>R2207076</b></p> <p><b>TGA</b></p> <p>REF OE : 81061300176 81061300171</p> <p>Dimensions faisceau : 685 X 892 X 66</p>		<p><b>R2701790</b></p> <p><b>BUS A51/54</b></p> <p>REF OE : 81061300184</p> <p>Dimensions faisceau : 840 X 892 X 66</p>
	<p><b>R309128</b></p> <p><b>BUS NG/NL</b></p> <p>REF OE : 81061300089</p> <p>Dimensions faisceau : 722 X 620 X 40</p>		<p><b>R2210153</b></p> <p><b>BUS A20/21/23/25/30/34/37</b></p> <p>REF OE : 81061300201</p> <p>Dimensions faisceau : 752 X 612 X 66</p>

## CONDENSEUR DE CLIMATISATION

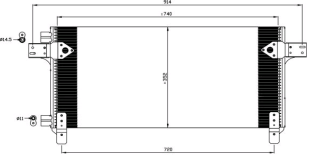
	<p><b>F40818033</b></p> <p><b>TGA</b></p> <p>REF OE : 81619200018 81619200032</p> <p>Dimensions faisceau : 750 X 351 X 16</p>
-------------------------------------------------------------------------------------	---------------------------------------------------------------------------------------------------------------------------------------

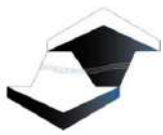

# RADIATEUR POIDS LOURDS

## MERCEDES

### EAU

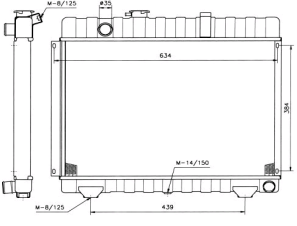
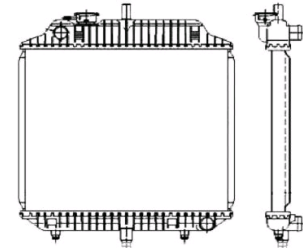
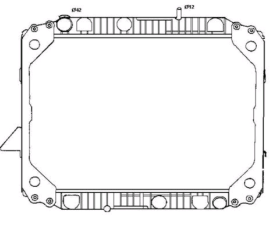
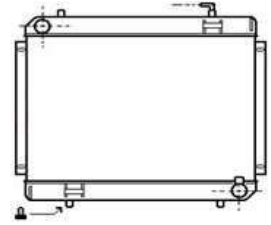
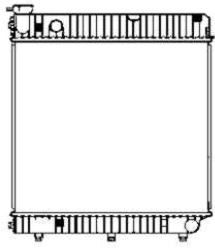
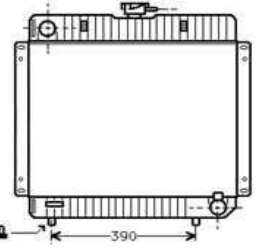
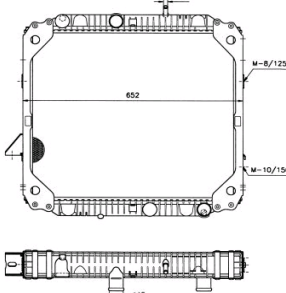
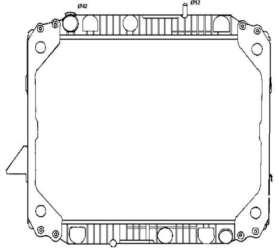
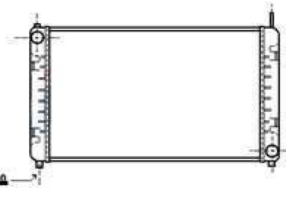
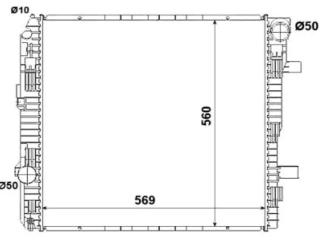
	<p><b>R730881</b></p> <p><i>207/307/407 D</i></p> <p>REF OE : 6015002903 6015000603 / 6015003003</p> <p><b>Dimensions faisceau :</b> 415 X 654 X 34</p>		<p><b>R730885</b></p> <p><i>MB100</i></p> <p>REF OE : 6315000502 / 6315000702 / A6315000502 / A6315000702</p> <p><b>Dimensions faisceau :</b> 415 X 492 X 34</p>
	<p><b>R730892</b></p> <p><i>709 /809D</i></p> <p>REF OE : 6735001603</p> <p><b>Dimensions faisceau :</b> 430 X 615 X 34</p>		<p><b>R730876</b></p> <p><i>813/913/1013/1113</i></p> <p>REF OE : 3185001902</p> <p><b>Dimensions faisceau :</b> 470 X 574 X 40</p>
	<p><b>R730883</b></p> <p><i>207307/407D 209/309/409D</i></p> <p>REF OE : 6015005103 6015007803</p> <p><b>Dimensions faisceau :</b> 473 X 530 X 35</p>		<p><b>R730869</b></p> <p><i>709/508/608/309D</i></p> <p>REF OE : 3105006502 / 3105000002</p> <p><b>Dimensions faisceau :</b> 480 X 500 X 34</p>
	<p><b>R730894</b></p> <p><i>814/914 114/1514</i></p> <p>REF OE : 6735001903</p> <p><b>Dimensions faisceau :</b> 515 X 620 X 53</p>		<p><b>FR730227</b></p> <p><i>1117 1317</i></p> <p>REF OE : 6775001703</p> <p><b>Dimensions faisceau :</b> 545 X 618 X 55</p>
	<p><b>R730888</b></p> <p><i>210 / 310 410 / 609 / 507</i></p> <p>REF OE : A6685000101</p> <p><b>Dimensions faisceau :</b> 630 X 371 X 23</p>		<p><b>R2203894</b></p> <p><i>ATEGO</i></p> <p>REF OE : A9705000503</p> <p><b>Dimensions faisceau :</b> 570 X 560 X 33</p>

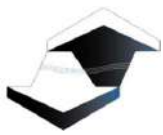

# RADIATEUR POIDS LOURDS

# MERCEDES

## EAU

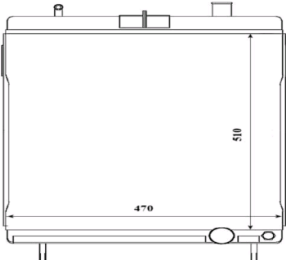
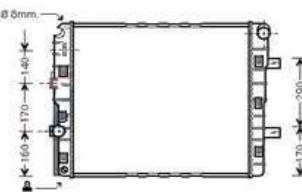
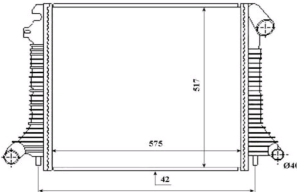
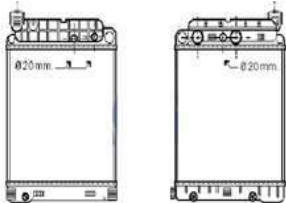
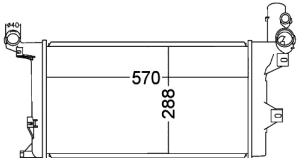
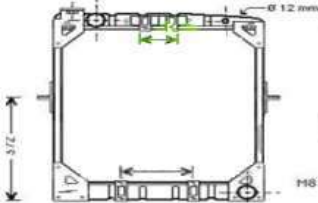
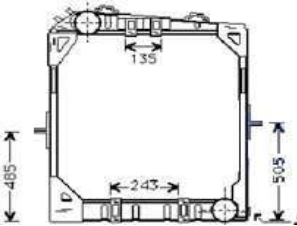
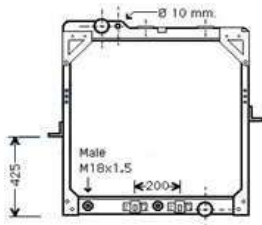
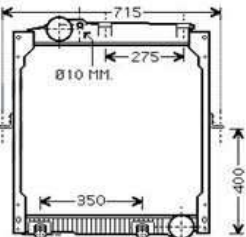
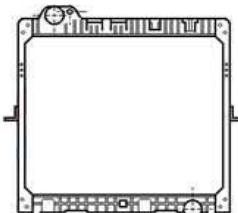
	<p><b>R58406</b></p> <p><b>UNIMOG</b></p> <p>REF OE : 4165000603</p> <p><b>Dimensions faisceau :</b> 510 X 470 X 55</p>		<p><b>R2203906</b></p> <p><b>ATEGO</b></p> <p>REF OE : A9705000403 / 9705000403</p> <p><b>Dimensions faisceau :</b> 570 X 560 X 40</p>
	<p><b>R732304</b></p> <p><b>ATEGO</b></p> <p>REF OE : A9735000803 A9735000903</p> <p><b>Dimensions faisceau :</b> 575 X 510 X 42</p>		<p><b>R14794</b></p> <p><b>ATEGO</b></p> <p>REF OE : A9405000303 / A9405000203 / A9405000403 / 9405000203 / 945000303 / 9405000403</p> <p><b>Dimensions faisceau :</b> 815 X 665 X 40</p>
	<p><b>R732303</b></p> <p><b>ATEGO</b> <i>(radiateur auxiliaire monté avec le R732304)</i></p> <p>REF OE : A9735000903</p> <p><b>Dimensions faisceau :</b> 570 X 288 X 42</p>		<p><b>FR730863</b></p> <p><b>SK1222 / 1422</b> <b>1622 / 1922</b></p> <p>REF OE : 0005017601</p> <p><b>Dimensions faisceau :</b> 610 X 630 X 72</p>
	<p><b>R730866</b></p> <p><b>SK 1633 / 1933</b> <b>2033 / 2233</b></p> <p>REF OE : 6455000403</p> <p><b>Dimensions faisceau :</b> 747 X 658 X 57</p>		<p><b>R730967</b></p> <p><b>SK 1748 / 1948</b> <b>2448 / 2648</b></p> <p>REF OE : 6555000303</p> <p><b>Dimensions faisceau :</b> 825 X 820 X 72</p>
	<p><b>R730886</b></p> <p><b>NG90/MK</b></p> <p>REF OE : A6505010601 6525016301</p> <p><b>Dimensions faisceau :</b> 630 X 624 X 43</p>		<p><b>R730887</b></p> <p><b>NG90/SK</b></p> <p>REF OE : A6555000003 / 6555000003</p> <p><b>Dimensions faisceau :</b> 662 X 660 X 43</p>

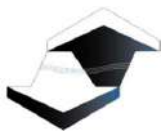

# RADIATEUR POIDS LOURDS

## MERCEDES

### EAU

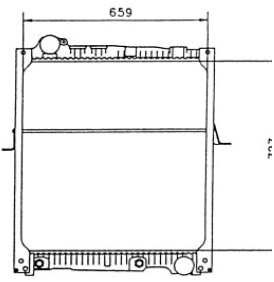
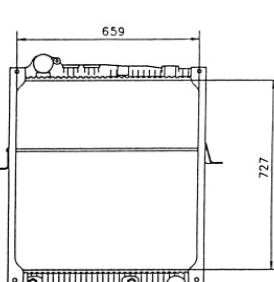
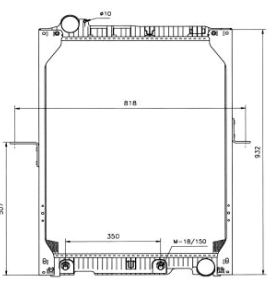
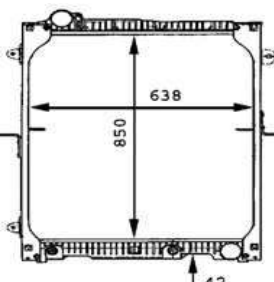
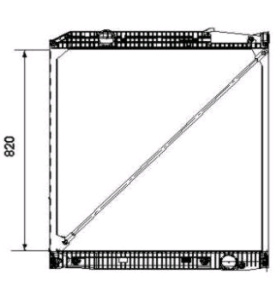
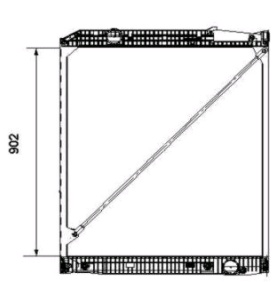
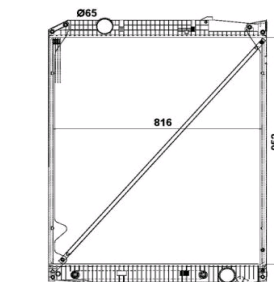
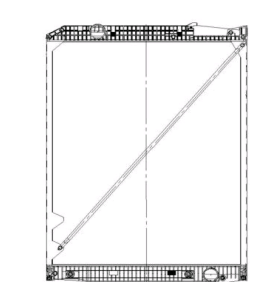
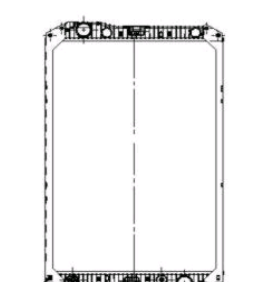
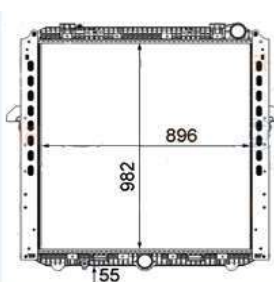
	<p><b>R2203997</b></p> <p><b>NG90/SK</b> <b>sans échangeur huile</b></p> <p>REF OE : A6525014401</p> <p><b>Dimensions faisceau :</b> <b>730 X 638 X 43</b></p>		<p><b>R730543</b></p> <p><b>NG90/SK</b> <b>avec échangeur huile</b></p> <p>REF OE : A6525014501/6525014401</p> <p><b>Dimensions faisceau :</b> <b>730 X 638 X 43</b></p>
	<p><b>R730544</b></p> <p><b>NG90</b></p> <p>REF OE : 6525016601 6525014201</p> <p><b>Dimensions faisceau :</b> <b>815 X 660 X 53</b></p>		<p><b>R730966</b></p> <p><b>NG90</b></p> <p>REF OE : A6525017001 / 6525017001</p> <p><b>Dimensions faisceau :</b> <b>847 X 660 X 43</b></p>
	<p><b>R62652</b></p> <p><b>ACTROS</b></p> <p>REF OE : A9425000903 A9425000603 9425001503</p> <p><b>Dimensions faisceau :</b> <b>820 X 829 X 43</b></p>		<p><b>R62653</b></p> <p><b>ACTROS</b></p> <p>REF OE : A9425001003 A9425000703 A9425001603</p> <p><b>Dimensions faisceau :</b> <b>902 X 829 X 43</b></p>
	<p><b>R62649</b></p> <p><b>ACTROS</b></p> <p>REF OE : A9425001103 /A9425001703/A9425003103/A9425 003203 / A9425003303</p> <p><b>Dimensions faisceau :</b> <b>955 X 829 X 43</b></p>		<p><b>R62791</b></p> <p><b>ACTROS</b></p> <p>REF OE : A9425001203 / A9425002303/A9425002503 /A9425002803 /A9425002903 /A9425003503</p> <p><b>Dimensions faisceau :</b> <b>1015 X 829 X 43</b></p>
	<p><b>R62571A</b></p> <p><b>AXOR</b></p> <p>REF OE : 9405000703 9405000603</p> <p><b>Dimensions faisceau :</b> <b>975 X 630 X 45</b></p>		<p><b>R8MK376737081</b></p> <p><b>ACTROS</b></p> <p>REF OE : A9605000801</p> <p><b>Dimensions faisceau :</b> <b>982 X 896 X 55</b></p>



# RADIATEUR POIDS LOURDS

# MERCEDES

## EAU

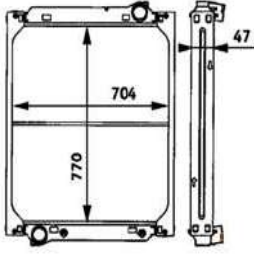
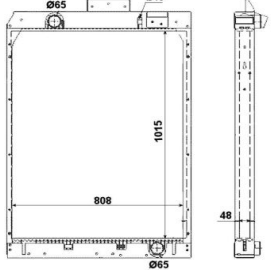
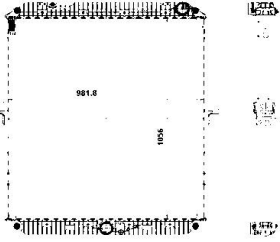
	<b>R1202197</b>
	<b>BUS 350/404</b>
	REF OE : A3565010201
	<b>Dimensions faisceau :</b> <b>770 X 704 X 47</b>
	<b>R58380</b>
	<b>BUS CITARO</b>
	REF OE : A6285000502
	<b>Dimensions faisceau :</b> <b>1015 X 810 X 52</b>
	<b>R67176</b>
	<b>ACTROS</b>
	REF OE : 9605002501 / 9605000901
	<b>Dimensions faisceau :</b> <b>1056 X 960 X 56</b>

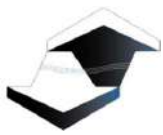

# RADIATEUR POIDS LOURDS

## MERCEDES

### ECHANGEUR D'AIR SURALIMENTE (R.A.S.)

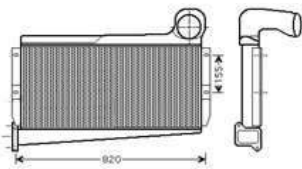
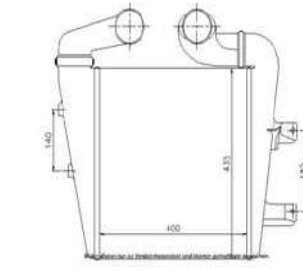
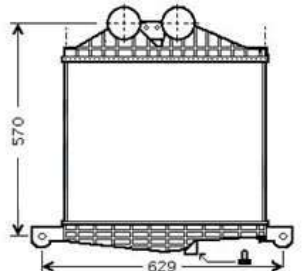
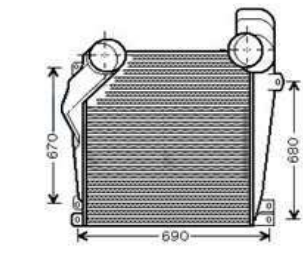
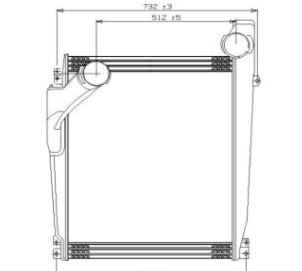
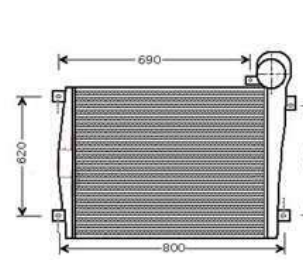
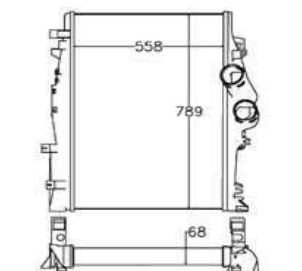
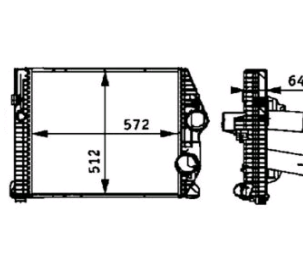
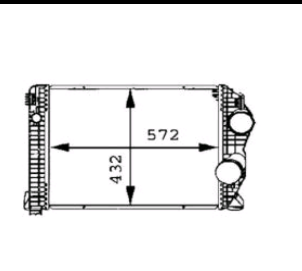
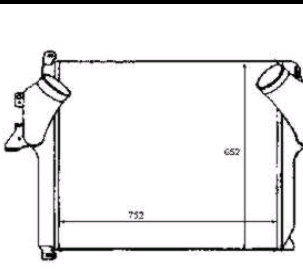
	<p><b>R2203929</b></p> <p><b>SK</b></p> <p>REF OE : A6555010001</p> <p><b>Dimensions faisceau :</b> <b>350 X 777 X 62</b></p>		<p><b>FR96906</b></p> <p><b>LK</b></p> <p>REF OE : A6775010101</p> <p><b>Dimensions faisceau :</b> <b>400 X 435 X 50</b></p>
	<p><b>R2204082</b></p> <p><b>LK</b></p> <p>REF OE : A6775011401</p> <p><b>Dimensions faisceau :</b> <b>420 X 552 X 52</b></p>		<p><b>R2204112</b></p> <p><b>SK</b></p> <p>REF OE : A6565010101</p> <p><b>Dimensions faisceau :</b> <b>600 X 797 X 50</b></p>
	<p><b>R816786</b></p> <p><b>SK/MK</b></p> <p>REF OE : A6565010001 / 6565000001 6535010001 / 6525012301</p> <p><b>Dimensions faisceau :</b> <b>600 X 797 X 50</b></p>		<p><b>R96938</b></p> <p><b>SK</b></p> <p>REF OE : A6555010201</p> <p><b>Dimensions faisceau :</b> <b>655 X 757 X 50</b></p>
	<p><b>R817281</b></p> <p><b>ATEGO</b></p> <p>REF OE : 9735010301 9735010201</p> <p><b>Dimensions faisceau :</b> <b>558 X 789 X 68</b></p>		<p><b>R2208044</b></p> <p><b>ATEGO</b></p> <p>REF OE : A9705010201 / A9705010604</p> <p><b>Dimensions faisceau :</b> <b>572 X 512 X 64</b></p>
	<p><b>R818752</b></p> <p><b>ATEGO</b></p> <p>REF OE : A9705010101</p> <p><b>Dimensions faisceau :</b> <b>572 X 432 X 52</b></p>		<p><b>R96971</b></p> <p><b>ACTROS</b></p> <p>REF OE : A9425010301 / 9425010001</p> <p><b>Dimensions faisceau :</b> <b>750 X 657 X 50</b></p>

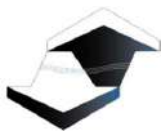

# RADIATEUR POIDS LOURDS

## MERCEDES

### ECHANGEUR D'AIR SURALIMENTE (R.A.S.)

	<p><b>R818755</b></p> <p><b>ACTROS /AXOR /ATEGO</b></p> <p>REF OE : 9405010201 / 9405010401</p> <p><b>Dimensions faisceau : 596 X 712 X 52</b></p>		<p><b>R818230</b></p> <p><b>AXOR</b></p> <p>REF OE : 9405010701</p> <p><b>Dimensions faisceau : 595 X 735 X 80</b></p>
	<p><b>R2204234</b></p> <p><b>ACTROS</b></p> <p>REF OE : A9425010201 / A9425010901 / A9425011001</p> <p><b>Dimensions faisceau : 750 X 857 X 62</b></p>		<p><b>RME4223</b></p> <p><b>ACTROS</b></p> <p>REF OE : 9425010701 9425010708</p> <p><b>Dimensions faisceau : 750 X 977 X 62</b></p>
	<p><b>R8ML376724281</b></p> <p><b>AXOR</b></p> <p>REF OE : A9405010301</p> <p><b>Dimensions faisceau : 630 X 890 X 64</b></p>		<p><b>R818775</b></p> <p><b>BUS CITARO</b></p> <p>REF OE : 6285004500/ 1499/1599</p> <p><b>Dimensions faisceau : 1000 X 645 X 73</b></p>

### CONDENSEUR DE CLIMATISATION

	<p><b>F4035772</b></p> <p><b>ACTROS</b></p> <p>REF OE : 9425000154 9425000054</p> <p><b>Dimensions faisceau : 673 X 457 X 22</b></p>		<p><b>F408FC351317641</b></p> <p><b>AXOR</b></p> <p>REF OE : A9405000254</p> <p><b>Dimensions faisceau : 600 X 457 X 22</b></p>
--	--------------------------------------------------------------------------------------------------------------------------------------	--	---------------------------------------------------------------------------------------------------------------------------------



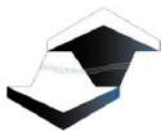



# RADIATEUR POIDS LOURDS

## RENAULT TRUCKS

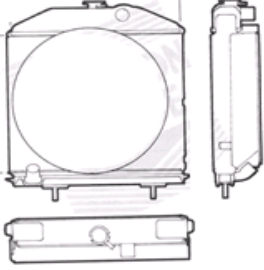
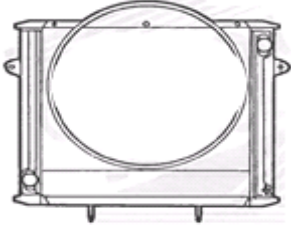
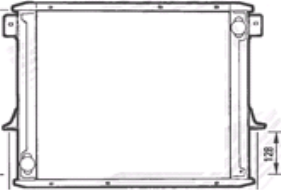

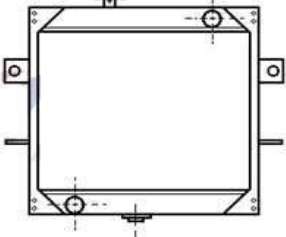
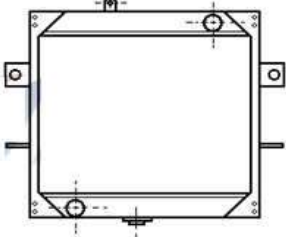
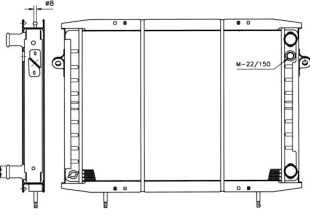
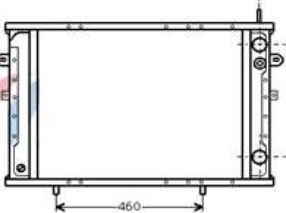
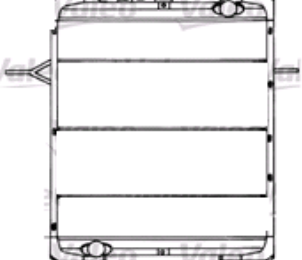
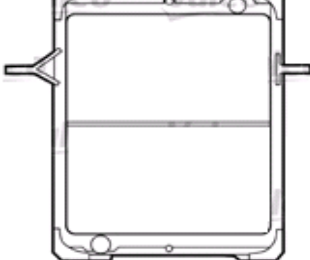

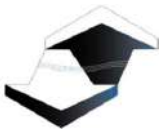
EAU

	<p><b>FR730687</b></p> <p><b>SG2/SG3</b></p> <p>REF OE : 500005270</p> <p><b>Dimensions faisceau :</b> 420 X 480 X 40</p>		<p><b>FR730350</b></p> <p><b>JK</b></p> <p>REF OE : 5000811944</p> <p><b>Dimensions faisceau :</b> 507 X 478 X 35</p>
	<p><b>FR730042</b></p> <p><b>S100</b></p> <p>REF OE : 5010039866</p> <p><b>Dimensions faisceau :</b> 507 X 478 X 35</p>		<p><b>FR730685</b></p> <p><b>K20</b></p> <p>REF OE : 0000713255</p> <p><b>Dimensions faisceau :</b> 570 X 438 X 35</p>
	<p><b>FR730676</b></p> <p><b>JP11/13/14</b></p> <p>REF OE : 5000547881</p> <p><b>Dimensions faisceau :</b> 570 X 530 X 57</p>		<p><b>FR730679</b></p> <p><b>JP13/JR21/JX21</b></p> <p>REF OE : 5000546599</p> <p><b>Dimensions faisceau :</b> 570 X 530 X 76</p>
	<p><b>FR730627</b></p> <p><b>B70/80/90/100/110</b></p> <p>REF OE : 5000397635 / 5000547881</p> <p><b>Dimensions faisceau :</b> 600 X 460 X 36</p>		<p><b>FR730668</b></p> <p><b>B120</b></p> <p>REF OE : 5000398274</p> <p><b>Dimensions faisceau :</b> 600 X 460 X 36</p>
	<p><b>FR730354</b></p> <p><b>S180/M180</b></p> <p>REF OE : 5000822905</p> <p><b>Dimensions faisceau :</b> 642 X 575 X 69</p>		<p><b>FR730570</b></p> <p><b>S130/150/170/220</b></p> <p>REF OE : 5000541986</p> <p><b>Dimensions faisceau :</b> 642 X 575 X 69</p>

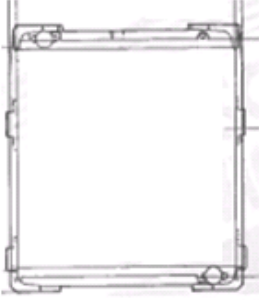

# RADIATEUR POIDS LOURDS RENAULT TRUCKS

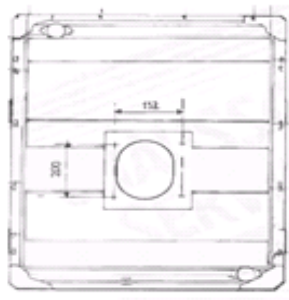
## EAU

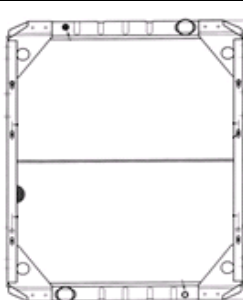
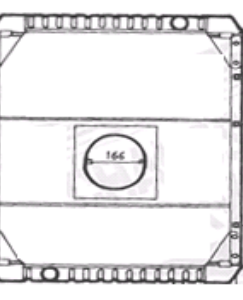
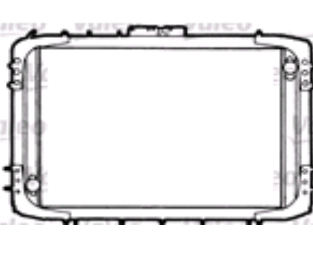
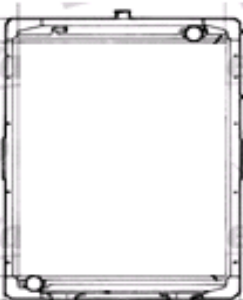
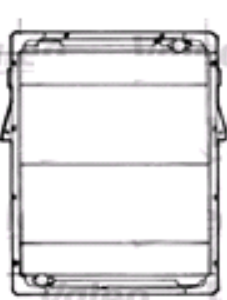

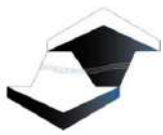
	<b>FR730694</b>  <i>GC/GR/GRH</i>  REF OE : 0027751238 <b>Dimensions faisceau :</b> 660 X 650 X 76		<b>FR730718</b>  <i>GLR</i>  REF OE : 5000789095 <b>Dimensions faisceau :</b> 660 X 650 X 76
	<b>FR730356</b>  <i>G 260/280/290/300/320/330</i>  REF OE : 5000787547 <b>Dimensions faisceau :</b> 770 X 640 X 57		<b>FR730692</b>  <i>G260 AVEC PDF</i>  REF OE : 5010140510 <b>Dimensions faisceau :</b> 770 X 640 X 76
	<b>FR730359</b>  <i>R310/340/350</i>  REF OE : 5000814443 <b>Dimensions faisceau :</b> 770 X 700 X 57		<b>R730733</b>  <i>G300/330</i>  REF OE : 5010140360 <b>Dimensions faisceau :</b> 785 X 690 X 47
	<b>FR730738</b>  <i>G220 AVEC PDF</i>  REF OE : 501014067 <b>Dimensions faisceau :</b> 785 X 690 X 47		<b>FR730725</b>  <i>C210/260/280</i>  REF OE : 5010213141 <b>Dimensions faisceau :</b> 850 X 640 X 58
	<b>FR730731</b>  <i>GBH 260/280</i>  REF OE : 5000821973 <b>Dimensions faisceau :</b> 850 X 700 X 76		<b>FR730358</b>  <i>R330/340TI/365/380</i>  REF OE : 5000748693 <b>Dimensions faisceau :</b> 885 X 700 X 587



# RADIATEUR POIDS LOURDS

## RENAULT TRUCKS

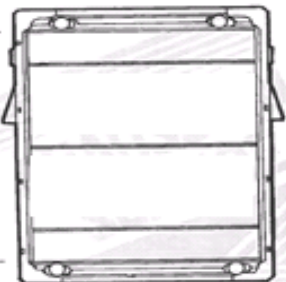
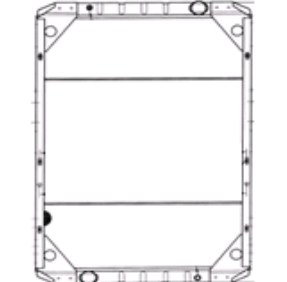
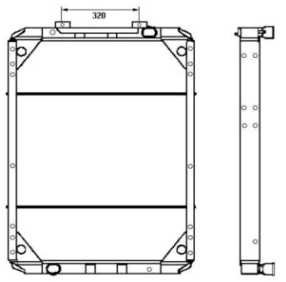

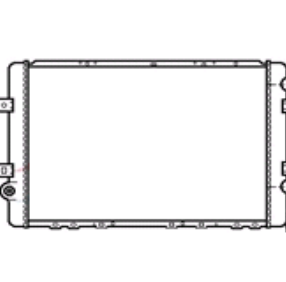
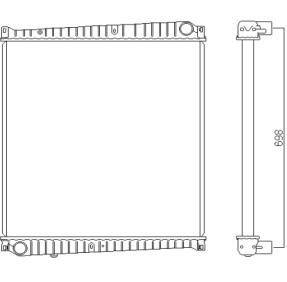
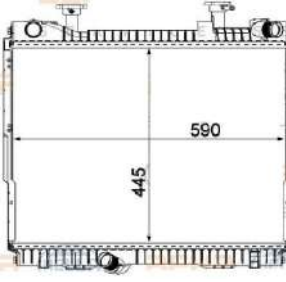
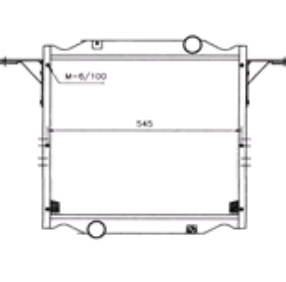
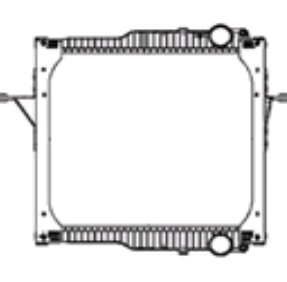

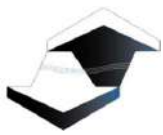
EAU

	<p><b>FR730626</b></p> <p><i>R390/420</i></p> <p>REF OE : 5000814471</p> <p>Dimensions faisceau : 892 X 691 X 63</p>		<p><b>R730734</b></p> <p><i>G340TI</i></p> <p>REF OE : 5010140366</p> <p>Dimensions faisceau : 925 X 687 X 47</p>
	<p><b>FR730386</b></p> <p><i>R340TI/380/385/385TI/ 420/430</i></p> <p>REF OE : 5010213197</p> <p>Dimensions faisceau : 965 X 744 X 50</p>		<p><b>R730624</b></p> <p><i>AE</i></p> <p>REF OE : 5010269182</p> <p>Dimensions faisceau : 980 X 816 X 53</p>
	<p><b>R732569</b></p> <p><i>MASCOTT</i></p> <p>REF OE : 5010382645 5010435102 / 5001849740</p> <p>Dimensions faisceau : 587 X 460 X 34</p>		<p><b>R624603</b></p> <p><i>MASCOTT</i></p> <p>REF OE : 5010619143 / 5001865411 748269946 / 7482164953 / 7485000988 7421009754</p> <p>Dimensions faisceau : 624 X 603 X 43</p>
	<p><b>R8MK376751221</b></p> <p><i>RVI MAXITY</i></p> <p>REF OE : 7485130190</p> <p>Dimensions faisceau : 445 X 590 X 40</p>	<p>NON COMMUNIQUE</p>	<p><b>R53860</b></p> <p><i>MAXITY</i></p> <p>REF OE : 21400MB41C / 7485130376 / 5001874692 / 5001874691 / 5001870203</p> <p>Dimensions faisceau : 445 x 590 x 40</p>
	<p><b>R52084</b></p> <p><i>MIDLINER</i></p> <p>REF OE : 5010283203 5001845917</p> <p>Dimensions faisceau : 455 X 540 X 53</p>		<p><b>R58403</b></p> <p><i>MIDLUM DXI</i></p> <p>REF OE : 7420809768 / 5001873307</p> <p>Dimensions faisceau : 495 X 568 X 50</p>

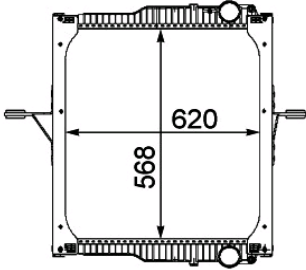
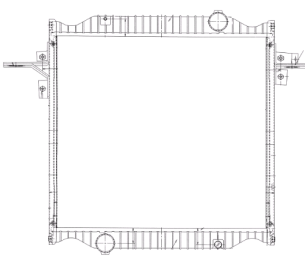
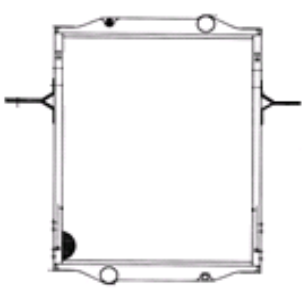

# RADIATEUR POIDS LOURDS RENAULT TRUCKS

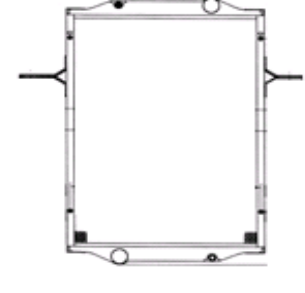
## EAU

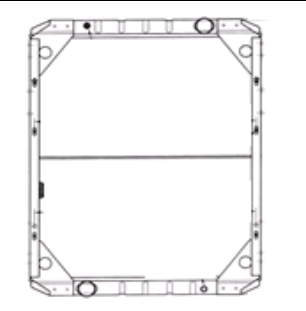
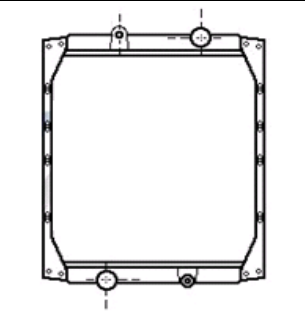
	<p><b>R8MK376733731</b></p> <p><i>MIDLUM</i></p> <p>REF OE : 7420809769 / 5001873317</p> <p>Dimensions faisceau : 620 x 568 x 52</p>		<p><b>FR530580</b></p> <p><i>MIDLUM</i></p> <p>REF OE : 5010315827 / 5010315442</p> <p>Dimensions faisceau : 530 x 580 x 53</p>
	<p><b>R731263</b></p> <p><i>MIDLINER</i></p> <p>REF OE : 5010283196 / 5010283199</p> <p>Dimensions faisceau : 650 X 540 X 53</p>		<p><b>R665580</b></p> <p><i>MIDLUM DCI</i></p> <p>REF OE : 5010315513/5001853068 5010315826</p> <p>Dimensions faisceau : 665 X 580 X 53</p>
	<p><b>R8MK376733751</b></p> <p><i>MIDLUM DXI</i></p> <p>REF OE : 7420809775/5001868221</p> <p>Dimensions faisceau : 710 X 568 X 52</p>		<p><b>R52083</b></p> <p><i>MIDLINER</i></p> <p>REF OE : 5010269003 5001838872</p> <p>Dimensions faisceau : 720 X 540 X 53</p>
	<p><b>R720580</b></p> <p><i>MIDLUM</i></p> <p>REF OE : 5010315825 5010315515</p> <p>Dimensions faisceau : 720 X 580 X 53</p>	<p>NON COMMUNIQUE</p>	<p><b>FR748580</b></p> <p><i>MIDLINER</i></p> <p>REF OE : 5010269109</p> <p>Dimensions faisceau : 748 X 580 X 43</p>
	<p><b>R730339</b></p> <p><i>RVI G300</i></p> <p>REF OE : 5010230826 5001856166</p> <p>Dimensions faisceau : 785 X 682 X 43</p>		<p><b>R730748</b></p> <p><i>G270/300/340TI MAXTER</i></p> <p>REF OE : 5010213427 5001834416 / 5010230474</p> <p>Dimensions faisceau : 870 X 690 X 53</p>

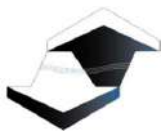

# RADIATEUR POIDS LOURDS

# RENAULT TRUCKS

EAU

	<p><b>R730337</b></p> <p><b>G340TI</b></p> <p>REF OE : 5010230824 5010140366</p> <p>Dimensions faisceau : <b>925 X 682 X 43</b></p>		<p><b>R731553</b></p> <p><b>PREMIUM 260</b></p> <p>REF OE : 5010315130 /5010230603 / 5010315131 / 5010315636 / 5001847494 / 5001847508</p> <p>Dimensions faisceau : <b>825 X 730 X 53</b></p>
	<p><b>R731554</b></p> <p><b>PREMIUM 385</b></p> <p>REF OE : 5010315639 / 5010315646 / 5010315132 / 5010315638 / 5001837210 / 5001856618</p> <p>Dimensions faisceau : <b>915 X 730 X 53</b></p>		<p><b>R2205333</b></p> <p><b>PREMIUM 260 DCI BOM</b></p> <p>REF OE : 5010315738 5001839113</p> <p>Dimensions faisceau : <b>810 X 735 X 43</b></p>
	<p><b>R2207982</b></p> <p><b>PREMIUM 270 DCI</b></p> <p>REF OE : 5010315845 5001866239</p> <p>Dimensions faisceau : <b>810 X 735 X 43</b></p>		<p><b>R2208025</b></p> <p><b>PREMIUM 320 DCI</b></p> <p>REF OE :5010315739 / 5001858494 / 5001858495 / 5001858496 / 50001868516</p> <p>Dimensions faisceau : <b>810 X 735 X 43</b></p>
	<p><b>R2204662</b></p> <p><b>KERAX 400 ITC</b></p> <p>REF OE : 5010315736 5001859137</p> <p>Dimensions faisceau : <b>900 X 734 X 53</b></p>		<p><b>R2209359</b></p> <p><b>KERAX 370/420 DCI</b></p> <p>REF OE : 5010315737 / 5001861376 / 5010619484 / 5001864777 / 5001864775</p> <p>Dimensions faisceau : <b>900 X 734 X 53</b></p>
	<p><b>R8MK376722071</b></p> <p><b>PREMIUM</b></p> <p>REF OE : 5010315738 / 5010315748</p> <p>Dimensions faisceau : <b>810 X 735 X 43</b></p>		<p><b>R2205335</b></p> <p><b>PREMIUM 420 DCI</b></p> <p>REF OE : 5010315764</p> <p>Dimensions faisceau : <b>970 X 735 X 43</b></p>

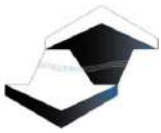

# RADIATEUR POIDS LOURDS

## RENAULT TRUCKS

### EAU

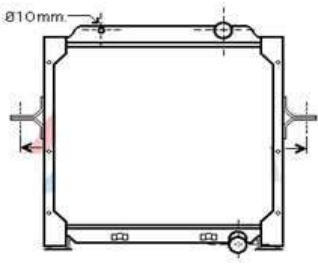
	<b>R8MK376745181</b>
	<b>PREMIUM DXI</b>
	REF OE : 7420810095 / 20810099 / 5001868514
<b>Dimensions faisceau :</b> <b>705 X 708 X 52</b>	

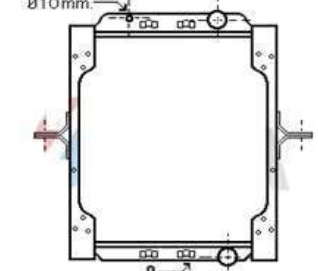
	<b>R8MK376745161</b>
	<b>KERAX 370/450 DXI</b>
	REF OE : 7420809878 / 5001867855 / 5001873354
<b>Dimensions faisceau :</b> <b>970 X 708 X 52</b>	

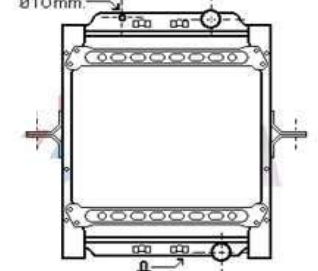
	<b>R8MK376745151</b>
	<b>PREMIUM 450/460 DXI</b>
	REF OE : 7485013126 / 5001867210 / 7485013127 / 7485020215 / 7421699253 / 7420775792
<b>Dimensions faisceau :</b> <b>990 X 708 X 52</b>	

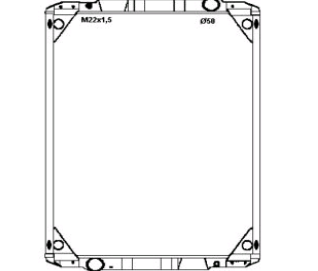
	<b>R732572</b>
	<b>AE DCI</b>
	REF OE : 5010315369 / 5010315373 / 5010514435 / 5001860493 / 5001848517 / 100310967
<b>Dimensions faisceau :</b> <b>975 X 738 X 43</b>	

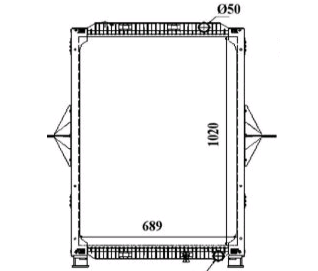
	<b>RRE2057</b>
	<b>AE DXI</b>
	REF OE : 7420833584 / 5001866280 / 5010619446
<b>Dimensions faisceau :</b> <b>1020 X 708 X 52</b>	

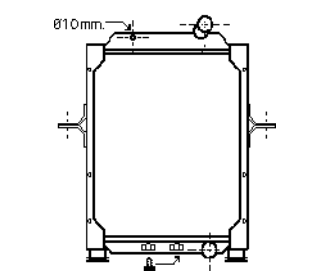
	<b>R8MK376745171</b>
	<b>PREMIUM LANDER DXI</b>
	REF OE : 5010619804 / 5001868516
<b>Dimensions faisceau :</b> <b>810 X 705 X 52</b>	

	<b>R733555</b>
	<b>SERIE C / T</b>
	REF OE : 7422062510 / 7485013540 / 7485013643
<b>Dimensions faisceau :</b> <b>805 X 888 X 52</b>	

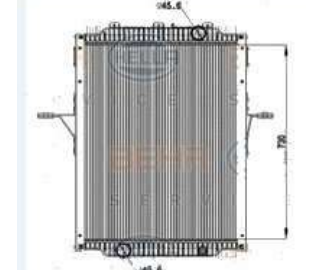
	<b>R8MK376908031</b>
	REF OE : 7421675258 / 21675277
<b>Dimensions faisceau :</b> <b>730 X 558 X 52</b>	

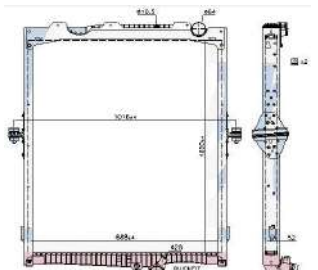
	<b>R733554</b>
	<b>SERIE T</b>
	REF OE : 7422062431 / 21167328 / 21208269 / 22062259 / 85013015
<b>Dimensions faisceau :</b> <b>1020 X 690 X 52</b>	

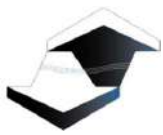

# RADIATEUR POIDS LOURDS

## RENAULT TRUCKS

### ECHANGEUR D'AIR SURALIMENTE (R.A.S.)



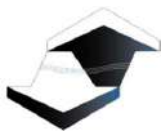



	<b>R816729</b>		<b>FR816696</b>
	<b>SERIE M ET S</b>		<b>SERIE M</b>
	REF OE : 5010332553 5000453321		REF OE : 5000452223
	Dimensions faisceau : 650 X 498 X 40		Dimensions faisceau : 720 X 491 X 43
	<b>R816687</b>		<b>FR816718</b>
	<b>SERIE G ET MS</b>		<b>SERIE G</b>
	REF OE : 5000541950		REF OE : 5010213280
	Dimensions faisceau : 650 X 498 X 40		Dimensions faisceau : 650 X 498 X 40
	<b>R816797</b>		<b>FR816798</b>
	<b>SERIE G</b>		<b>SERIE G</b>
	REF OE : 5010140361 / 5001823447		REF OE : 5010140367
	Dimensions faisceau : 600 X 687 X 40		Dimensions faisceau : 600 X 793 X 43
	<b>R816607</b>		<b>R816785</b>
	<b>SERIE G</b>		<b>SERIE G</b>
	REF OE : 5000787548		REF OE : 5010051589
	Dimensions faisceau : 780 X 637 X 40		Dimensions faisceau : 920 X 623 X 45
	<b>R816612</b>		<b>R816603</b>
	<b>SERIE R</b>		<b>SERIE R</b>
	REF OE : 5000748694		REF OE : 5001823421 0027752002
	Dimensions faisceau : 650 X 682 X 63		Dimensions faisceau : 780 X 687 X 40

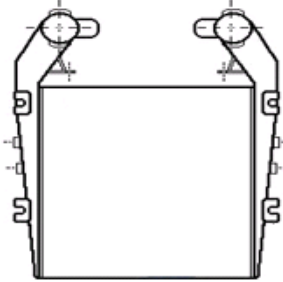
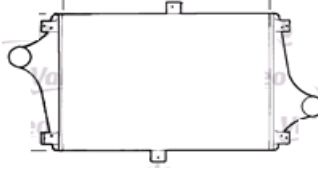
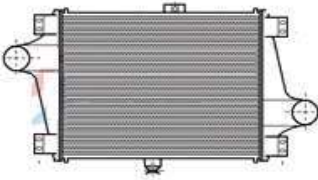

# RADIATEUR POIDS LOURDS

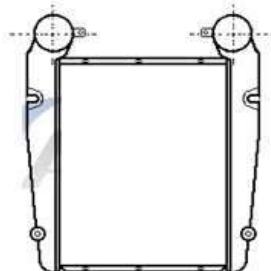
## RENAULT TRUCKS

### ECHANGEUR D'AIR SURALIMENTE (R.A.S.)

	<p><b>FR816717</b></p> <p><b>SERIE R</b></p> <p>REF OE : 5430121530</p> <p>Dimensions faisceau : 650 X 797 X 50</p>		<p><b>FR816688</b></p> <p><b>SERIE C</b></p> <p>REF OE : 5010213912</p> <p>Dimensions faisceau : 860 X 597 X 40</p>
	<p><b>FR816693</b></p> <p><b>SERIE C</b></p> <p>REF OE : 500749470</p> <p>Dimensions faisceau : 860 X 687 X 43</p>		<p><b>R817380</b></p> <p><b>MASCOTT</b></p> <p>REF OE : 5010382814/5001849748 7700838133</p> <p>Dimensions faisceau : 627 X 182 X 40</p>
	<p><b>R625203</b></p> <p><b>MASCOTT</b></p> <p>REF OE : 5010619437 5010875210</p> <p>Dimensions faisceau : 625 X 225 X 52</p>		<p><b>FR440697</b></p> <p><b>RVI MIDLINER</b></p> <p>REF OE : 5010213802</p> <p>Dimensions faisceau : 440 X 697 X 62</p>
	<p><b>FR480570</b></p> <p><b>RVI MIDLUM</b></p> <p>REF OE : 5010315824</p> <p>Dimensions faisceau : 480 X 570 X 62</p>		<p><b>FR480695</b></p> <p><b>RVI MIDLINER</b></p> <p>REF OE : 5010315823 5010315512</p> <p>Dimensions faisceau : 480 X 697 X 62</p>
<p><b>En Développement</b></p>	<p><b>EN COURS</b></p> <p><b>MIDLUM190 DCI</b></p> <p>REF OE : 7420809784</p> <p>Dimensions faisceau : 505 X 560 X 50</p>		<p><b>R8ML376756091</b></p> <p><b>MIDLUM 220 DCI</b></p> <p>REF OE : 7420809793</p> <p>Dimensions faisceau : 532 X 630 X 52</p>



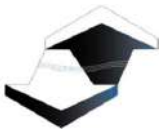



# RADIATEUR POIDS LOURDS

## RENAULT TRUCKS

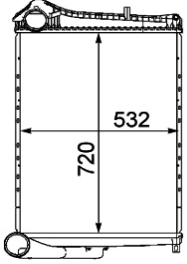
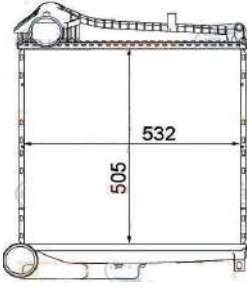
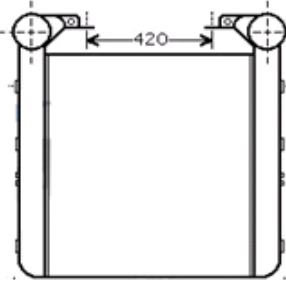
### ECHANGEUR D'AIR SURALIMENTE (R.A.S.)

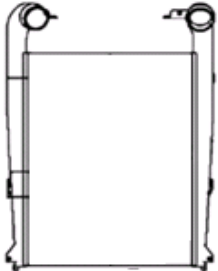
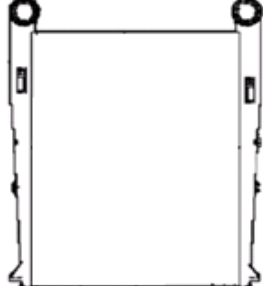
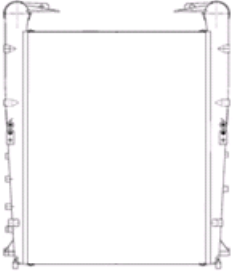
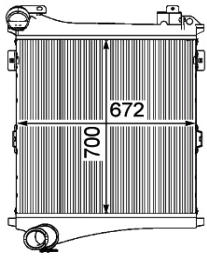

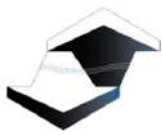
	<p><b>R8ML376746381</b></p> <p><b>MIDLUM 240/280 DXI</b></p> <p>REF OE : 7420809794/5001873750 7482142855</p> <p><b>Dimensions faisceau : 720 X 532 X 50</b></p>		<p><b>R8ML376751201</b></p> <p><b>MIDLUM</b></p> <p>REF OE : 7482143050</p> <p><b>Dimensions faisceau : 505 X 532 X 50</b></p>
	<p><b>R816978</b></p> <p><b>PREMIUM 210/300</b></p> <p>REF OE : 5010230487/5001837174 / 5001856656 / 5001857172</p> <p><b>Dimensions faisceau : 630 X 837 X 62</b></p>		<p><b>R816979</b></p> <p><b>PREMIUM340/385</b></p> <p>REF OE : 5010230488</p> <p><b>Dimensions faisceau : 630 X 917 X 62</b></p>
	<p><b>R2207583</b></p> <p><b>PREMIUM 420 DCI</b></p> <p>REF OE : 5010315765 5010315841 / 5001858491</p> <p><b>Dimensions faisceau : 595 X 817 X 62</b></p>		<p><b>R2209002</b></p> <p><b>PREMIUM / KERAX DCI</b></p> <p>REF OE : 5010315735 / 5010514245 / 5001858498 / 5010315844 / 5001858499</p> <p><b>Dimensions faisceau : 595 X 817 X 62</b></p>
	<p><b>R8ML376746281</b></p> <p><b>KERAX DXI</b></p> <p>REF OE : 7482358757 / 5010619582 / 7485003670 / 5001867853</p> <p><b>Dimensions faisceau : 595 X 817 X 62</b></p>		<p><b>R8ML376746341</b></p> <p><b>PREMIUM 280/320 DXI</b></p> <p>REF OE : 7420968088 / 7420968089</p> <p><b>Dimensions faisceau : 700 X 672 X 50</b></p>



# **RADIATEUR POIDS LOURDS**

# **RENAULT TRUCKS**

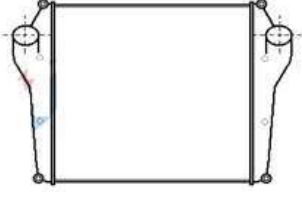
## **ECHANGEUR D'AIR SURALIMENTE (R.A.S.)**

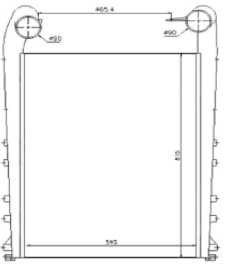
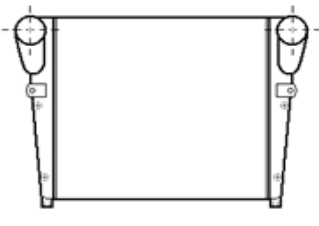
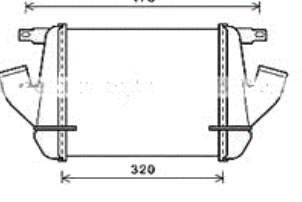
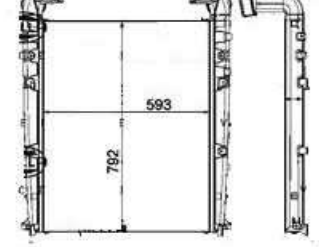

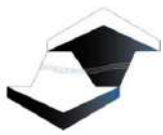
	<b>R816730</b>		<b>R816961</b>
	<b>AE / sorties diametre 80mm</b>		<b>AE / sorties diametre 90mm</b>
	REF OE : 5010066292		REF OE : 5010269987
	<b>Dimensions faisceau : 755 x 797 x 62</b>		<b>Dimensions faisceau : 755 x 797 x 62</b>
	<b>R8ML376728731</b>		<b>R817181</b>
	<b>PREMIUM / AE DXI</b>		<b>AE DCI</b>
	REF OE : 7420833583 / 7485003667 / 5010619295 / 5001873716 / 7482358714 / 7485003821		REF OE : 5001845520 / 5010315371 / 5001856665 / 5001858516
	<b>Dimensions faisceau : 595 X 817 X 62</b>		<b>Dimensions faisceau : 690 X 690 X 50</b>
	<b>R8ML376751231</b>		<b>R8ML376308051</b>
	<b>RVI MAXITY</b>		<b>RVI D</b>
	REF OE : 5001873638 / 14461MA70A		REF OE : 7421657617 / 21676395
	<b>Dimensions faisceau : 305 X 272 X 64</b>		<b>Dimensions faisceau : 593 X 797 X 50</b>



# **RADIATEUR POIDS LOURDS**

# **RENAULT TRUCKS**

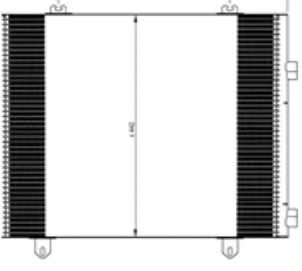
## CONDENSEUR DE CLIMATISATION

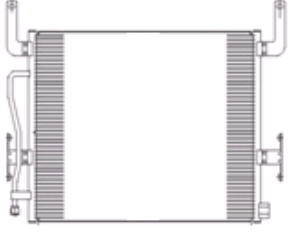
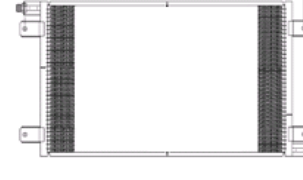
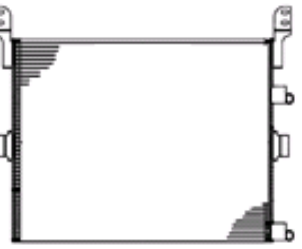
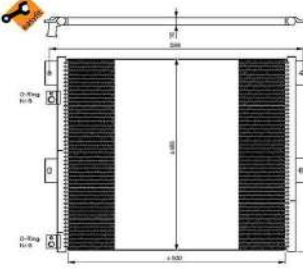
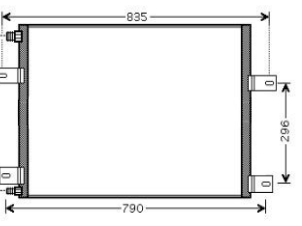
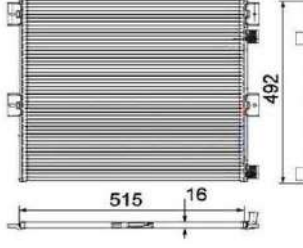
	<b>F40817379</b>		<b>F40RE5075</b>
	<b>MASCOTT</b>		<b>MIDLUM</b>
	REF OE : 5010382644		REF OE : 5010514079 5010315259 / 5010619265
	<b>Dimensions faisceau : 510 X 440 X 16</b>		<b>Dimensions faisceau : 530 X 520 X 16</b>
	<b>F40816980</b>		<b>F40816962</b>
	<b>PREMIUM DCI</b>		<b>AE</b>
	REF OE : 5010619734 5010315281		REF OE : 5000752789
	<b>Dimensions faisceau : 590 X 462 X 22</b>		<b>Dimensions faisceau : 759 X 406 X 23</b>
	<b>F408FC351317661</b>		<b>F4035924</b>
	<b>PREMIUM / AE DXI</b>		<b>MIDLUM</b>
	REF OE : 5010619517 5010514735 / 5001875436		REF OE : 7420809759
	<b>Dimensions faisceau : 610 X 478 X 16</b>		<b>Dimensions faisceau : 500 X 485 X 16</b>
	<b>F4035638</b>		<b>F4035924</b>
	<b>MAGNUM</b>		<b>MIDLUM</b>
	REF OE : 5001864981		REF OE : 7420809759
	<b>Dimensions faisceau : 650 x 500 x 22</b>		<b>Dimensions faisceau : 515 x 492 x 16</b>

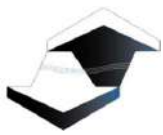

# RADIATEUR POIDS LOURDS

# SCANIA

## EAU

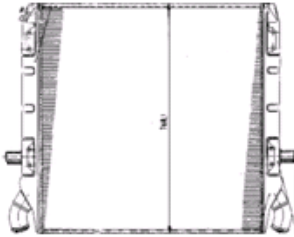
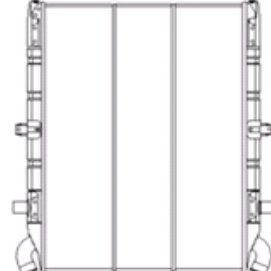
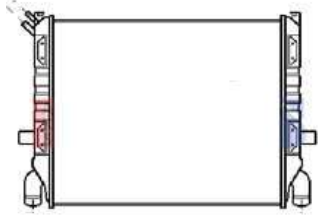
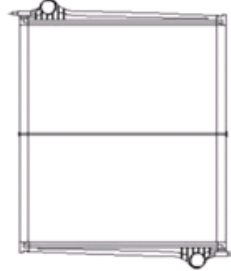
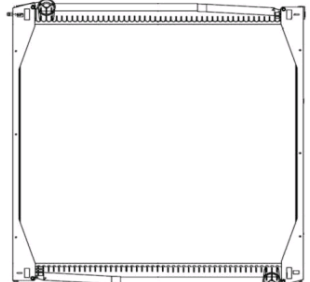
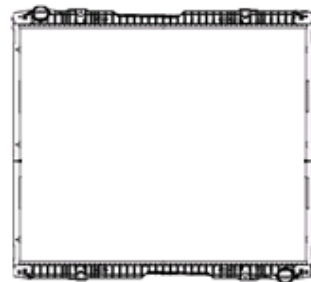
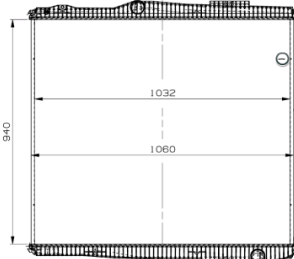
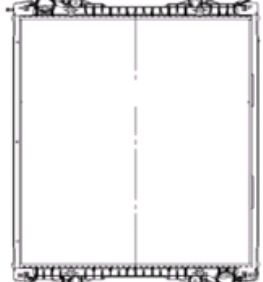
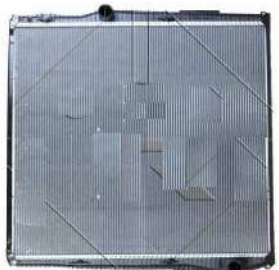
	<p><b>R730636</b></p> <p><b>SERIE 2</b></p> <p>REF OE : 1100630 / 310080 / 334840 / 570453 / 570642</p> <p>Dimensions faisceau : 720 X 750 X 57</p>		<p><b>R730638</b></p> <p><b>SERIE 3</b></p> <p>REF OE : 371625 / 1321888 / 570451</p> <p>Dimensions faisceau : 715 X 1004 X 46</p>
	<p><b>R64072</b></p> <p><b>SERIE 3</b></p> <p>REF OE : 1100631 / 310081</p> <p>Dimensions faisceau : 970 X 764 X 53</p>		<p><b>R503604</b></p> <p><b>SERIE 4</b></p> <p>REF OE : 1365371 / 570468 / 570473 / 570482 / 1439504 / 1516491 / 7517001</p> <p>Dimensions faisceau : 860 X 710 X 43</p>
	<p><b>R503603</b></p> <p><b>SERIE 4</b></p> <p>REF OE : 1327249 / 1397435 / 1408881 / 570465 / 570474 / 570491 / 1442751 / 1764886</p> <p>Dimensions faisceau : 860 X 964 X 43</p>		<p><b>R509739</b></p> <p><b>SERIE R</b></p> <p>REF OE : 1527653 / 1741588 / 570485 / 1784616 / 1769997</p> <p>Dimensions faisceau : 860 X 990 X 40</p>
	<p><b>R509895</b></p> <p><b>SERIE R</b></p> <p>REF OE : 1781365</p> <p>Dimensions faisceau : 940 X 1060 X 43</p>		<p><b>R519743</b></p> <p><b>BUS P230/420</b></p> <p>REF OE : 1766125 / 1784615 / 1491710</p> <p>Dimensions faisceau : 860 X 690 X 40</p>
	<p><b>R67291</b></p> <p><b>SERIE P / R / G / T</b></p> <p>REF OE : 1851542 / 2027572</p> <p>Dimensions faisceau : 940 X 980 X 42</p>		

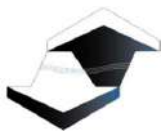



# RADIATEUR POIDS LOURDS

# SCANIA

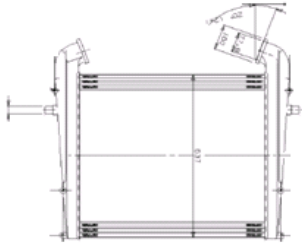
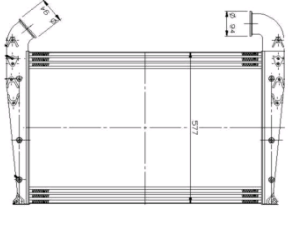
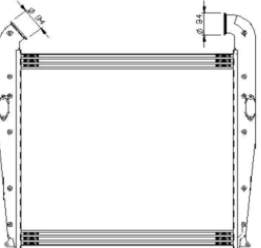
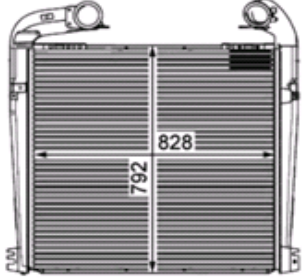
## ECHANGEUR D'AIR SURALIMENTE (R.A.S.)

	<b>FR91201</b>		<b>R96992</b>
	<b>SERIE 2 ET 3</b>		<b>SERIE 4</b>
	REF OE : 1100086		REF OE : 1365209 / 1400937 / 1516489
	<b>Dimensions faisceau : 675 X 637 X 62</b>		<b>Dimensions faisceau : 825 X 577 X 62</b>
	<b>R2204133</b>		<b>R8ML376730571</b>
	<b>SERIE 4</b>		<b>SERIE R</b>
	REF OE : 1430718 / 1373517 / 1384059 / 570472 / 1394140 / 1408882 / 1477051 / 1516492 / 1764885		REF OE : 1547316 / 1795730 / 1766617
	<b>Dimensions faisceau : 825 X 797 X 62</b>		<b>Dimensions faisceau : 825 X 797 X 62</b>

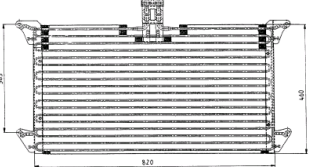
## CONDENSEUR DE CLIMATISATION

	<b>F4035061</b>		<b>F4035762</b>
	<b>SERIE 4</b>		<b>SERIE R</b>
	REF OE : 1449757 / 1354110 / 20223750		REF OE : 1446258 / 1790840 / 1782207
	<b>Dimensions faisceau : 860 X 455 X 26</b>		<b>Dimensions faisceau : 706 X 373 X 17</b>
	<b>F40940440</b>		
	<b>SERIE G / R / T</b>		
	REF OE : 1921284 / 1854555		
	<b>Dimensions faisceau : 942 X 341 X 16</b>		

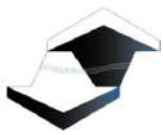

# RADIATEUR POIDS LOURDS

# VOLVO

## EAU

	<b>R730601</b>
	<b>F10/F12</b>
	REF OE : 273862222
	<b>Dimensions faisceau :</b> 820 X 792 X 53

	<b>R733495</b>
	<b>FL6</b>
	REF OE : 20555288 / 8112977 / 8149641
	<b>Dimensions faisceau :</b> 660 x 560 x 42

	<b>R730223</b>
	<b>FH12/16</b>
	REF OE : 1676435 / 1676635 / 8112961 / 8149683 / 1276435 / 8113190 / 8149326 / 8149362
	<b>Dimensions faisceau :</b> 900 X 900 X 43

	<b>R8MK376908031</b>
	<b>FL</b>
	REF OE : 7421675258 / 21675277
	<b>Dimensions faisceau :</b> 730 X 558 X 52

	<b>R733497</b>
	<b>FL6</b>
	REF OE : 20555291
	<b>Dimensions faisceau :</b> 720 X 558 X 42

	<b>R733554</b>
	<b>SERIE T</b>
	REF OE : 7422062431 / 21167328 / 21208269 / 22062259 / 85013015
	<b>Dimensions faisceau :</b> 1020 X 690 X 52

	<b>R730222</b>
	<b>FH12/16</b>
	REF OE : 8112566 / 1665249 / 1665349 / 1676436 / 1676636 / 8112960 / 8113186 / 8149370
	<b>Dimensions faisceau :</b> 900 X 733 X 52

	<b>R730222</b>
	<b>FMX</b>
	REF OE : 21649619 / 82020561 / 85026561 / 22374733 / 100314589 / 100316845 / 22174101 / 22039778
	<b>Dimensions faisceau :</b> 945 X 730 X 52

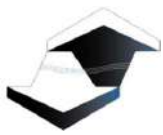

# RADIATEUR POIDS LOURDS

# VOLVO

## ECHANGEUR D'AIR SURALIMENTE (R.A.S.)

## CONDENSEUR DE CLIMATISATION

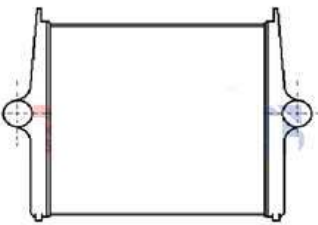
	<b>FR30401</b>
	<b>F10/F12</b>
	REF OE : 1664351 5003348
	<b>Dimensions faisceau :</b> 470 X 777 X 62

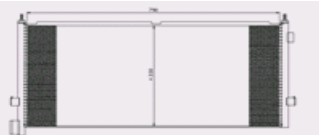
	<b>F4035314</b>
	<b>FH12/FH16</b>
	REF OE : 3980841

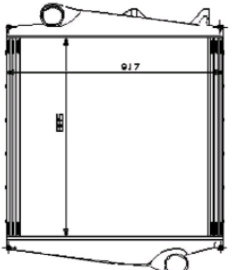
	<b>R96961</b>
	<b>FH12/FH16</b>
	REF OE : 1675428
	<b>Dimensions faisceau :</b> 885 X 917 X 62

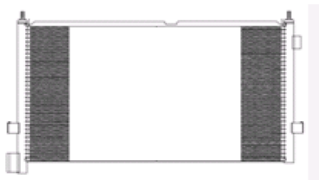
	<b>F4094578</b>
	<b>FH12/16</b>
	REF OE : 3981637 / 2051536 / 21086304
	<b>Dimensions faisceau :</b> 635 X 335 X 21

	<b>R30392</b>
	<b>FM</b>
	REF OE : 21649624 / 100314536 / 21209725 / 818525
	<b>Dimensions faisceau :</b> 945 x 727 x 68 mm

	<b>R309003</b>
	<b>FH12/FM7/FM12</b>
	REF OE : 1665242 / 1676631 / 8112564 / 8113220 / 3183747 / 20566842 / 20758816
	<b>Dimensions faisceau :</b> 885 X 757 X 62

## ***VISCO-COUPLEUR NEUF***



### **Distribution :**

- ventilateurs complets

- Pales plastiques

**TOUTES MARQUES**

---

### **Distribution Noyaux TOUTES MARQUES :**

- Embrayage visco-coupleur,
- Embrayage électromagnétique,
- Embrayage à friction.







# ECHANGEUR D'HUILE NEUF

Quel échangeur choisir ?		H20CA500	H20CA600	H20CA1800	H20CA2100
Débit d'huile litres / minutes	Minimal	10	20	80	100
	Maximal	80	130	180	230

## H20CA500

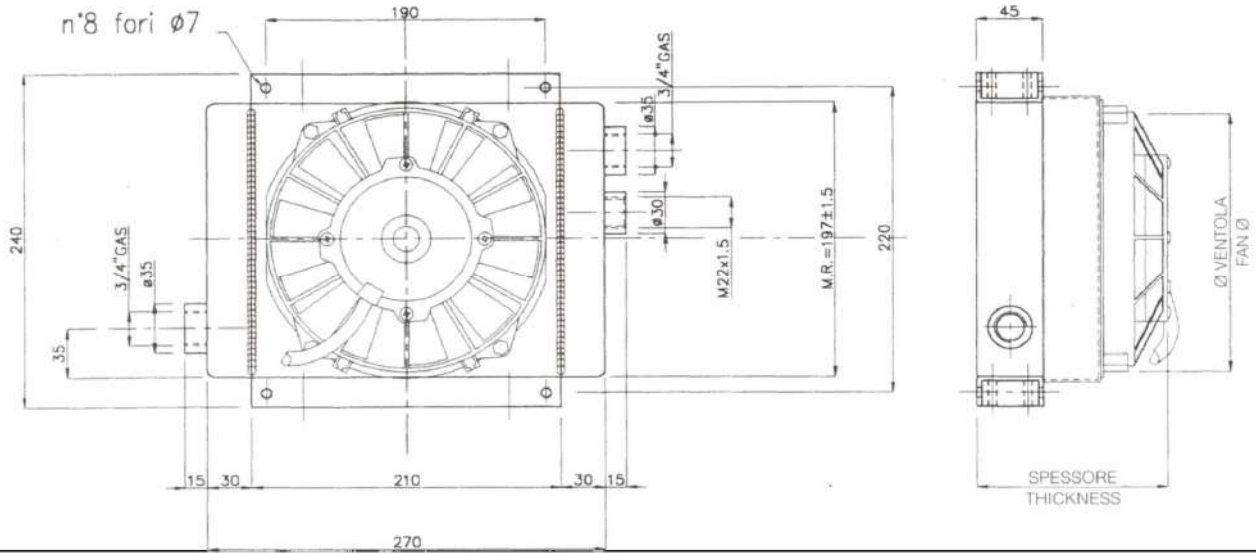

## H20CA600

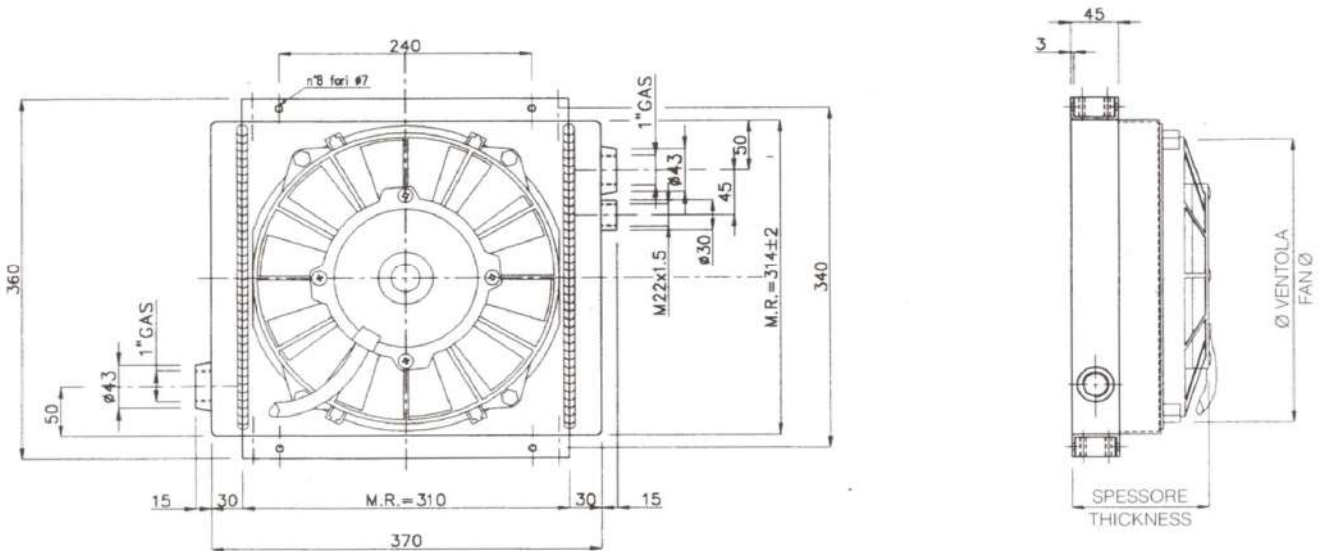



# ECHANGEUR D'HUILE NEUF

H20CA1800

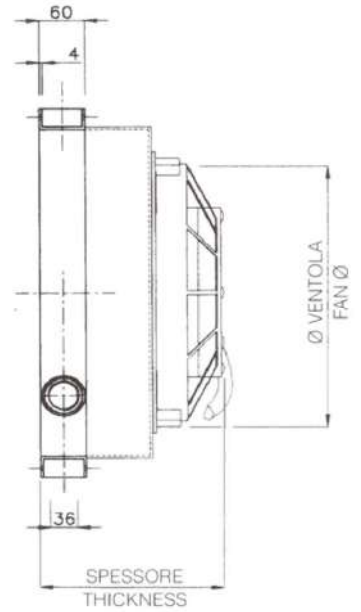
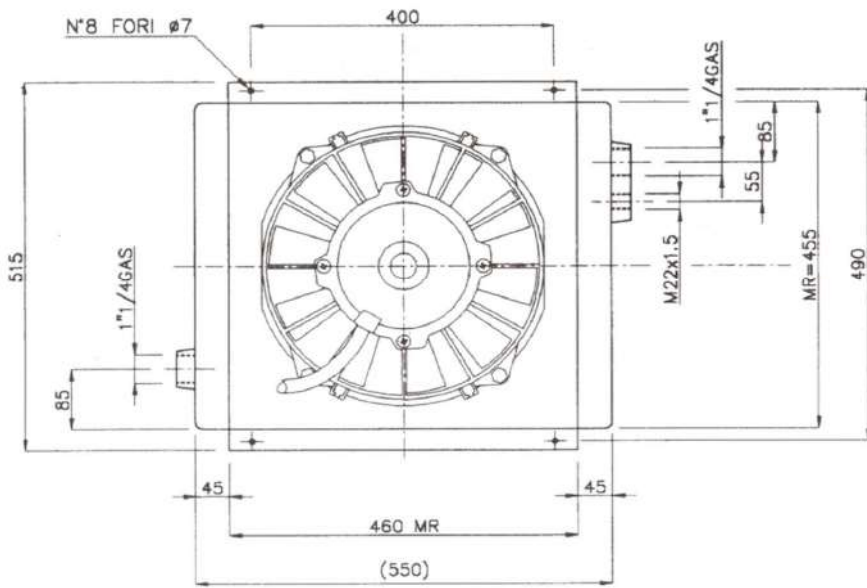

H20CA2100

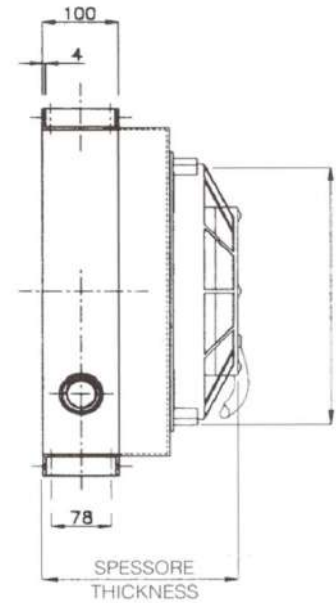
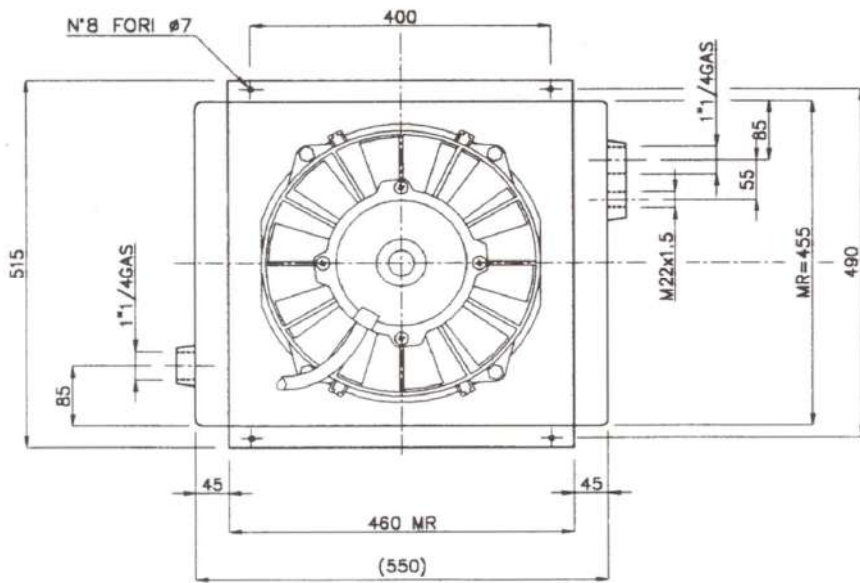

POSSIBILITE DE COMMANDER :

**VENTILATEUR AU DETAIL,  
ASPIRANT - SOUFFLANT  
12 Volts - 24 Volts -  
Hydrauliques**

**SONDES ETANCHES,  
NOUS CONSULTER.**



## SUPPORTS FIXATION

REFERENCE	LONGUEUR	HAUTEUR CAOUTCHOUC	FILETAGE
SUPPORTCA5001 (Equerre)	250 mm	2 x 50 mm	5 mm
SUPPORTCA5002 (Plat)	250mm	50 mm	5 mm
SUPPORTCA6001 (Equerre)	390 mm	2 x 50 mm	5 mm
SUPPORTCA6002 (Plat)	390 mm	50 mm	5 mm
SUPPORTCA18001 (Equerre)	450 mm	125 mm	5 mm
SUPPORTCA18002 (Plat)	450 mm	2 x 65 mm	5 mm
SUPPORTCA21001 (Equerre)	450 mm	165 mm	5 mm
SUPPORTCA21002 (Plat)	450 mm	2 x 105 mm	5 mm

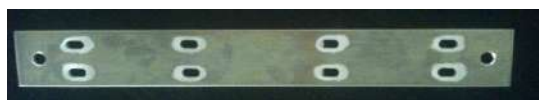

### DURITE DROITE ANNELEE TYPE "TUBANO"

#### LONGUEUR 1M

Ø intérieur 20 : 9DU14123

Ø intérieur 25 : 9DU14106

Ø intérieur 31,5 : 9DU14107

Ø intérieur 33,5 : 9DU14108

Ø intérieur 37 : 9DU 14109

Ø intérieur 44 : 9DU14110

Ø intérieur 48 : 9DU14111

Ø intérieur 55 : 9DU17325



### DURITE COUDEE 90°

Ø 15 MM LONGUEUR 150MM : 9DUcouDE15

Ø 18 MM LONGUEUR 150MM : 9DUcouDE18

Ø 25 MM LONGUEUR 150MM : 9DUcouDE25

Ø 28 MM LONGUEUR 200MM : 9DUcouDE28

Ø 30 MM LONGUEUR 200MM : 9DUcouDE30

Ø 32 MM LONGUEUR 200MM : 9DUcouDE32

Ø 35 MM LONGUEUR 300MM : 9DUcouDE35

Ø 38 MM LONGUEUR 300MM : 9DUcouDE38

Ø 40 MM LONGUEUR 300MM : 9DUcouDE40

Ø 45 MM LONGUEUR 300MM : 9DUcouDE45

Ø 55 MM LONGUEUR 300MM : 9DUcouDE55

### DURITE AU METRE

Température de Service : -30°C à +110°C

#### LONGUEUR SUR MESURE (minimum 250mm)

Ø 15MM : 9DU15

Ø 16MM : 9DU16

Ø 18MM : 9DU18

Ø 25MM : 9DU25

Ø 28MM : 9DU28

Ø 30MM : 9DU30

Ø 32MM : 9DU32

Ø 35MM : 9DU35

Ø 38MM : 9DU38

Ø 40MM : 9DU40

Ø 42MM : 9DU42

Ø 45MM : 9DU45

Ø 55MM : 9DU55





**CATALDI s.a.s. est spécialisée  
dans la rénovation, l'assemblage  
des systèmes de refroidissement.**

Elle met à votre service **42 ans** d'expérience.

Elle est certifiée ISO 9001 et ISO 14001 par l'AFNOR.

**Sa capacité d'adaptation**, sa souplesse de structure,  
sa parfaite connaissance du marché, **sa maîtrise produit**,  
en font l'un des **leaders dans sa corporation.**

**Le Service, la Qualité et la Compétence  
sont des priorités reconnues par ses clients.**



**CATALDI s.a.s.**

Z.A. Girouflat  
47200 Marmande

Tél : 05 53 64 33 36  
Fax : 05 53 64 21 53

[stephane.cataldi@cataldi.fr](mailto:stephane.cataldi@cataldi.fr)  
[www.cataldi.fr](http://www.cataldi.fr)

Sté par actions simplifiée au capital de 500 000€  
RCS Agen 378 956 239  
Siret 378 956 239 000 16  
N° Identification : FR17 378 956 239